



SUNWU
POLY

Door Frame
Mouldings
Picture Frame

CONTENT

01

Materials
Property
Product Overview

02

Door Frame

03

Mouldings Collection

- Classic
 - Contemporary
 - Pakakarn
 - Abbha
 - Lalamy
 - Art deco
 - Minimal
 - Bei-mu
 - Modern
 - Colonail
 - Modern luxury
-

04

Picture Frame

- Classic
- Modern
- Luxury
- Vintage
- Minimal

ประวัติ

“กว่า 40 ปีที่เรามุ่งมั่นพัฒนา”



1974

ก่อตั้งโรงงาน
ไม้กรอบรูป ทริเพาไพร์ จำกัด
ผลิตไม้เส้นกรอบรูปด้วยไม้จริง

1994

นำเข้าเครื่องจักรจากอิตาลี
เพื่อการผลิตที่มีคุณภาพ

1993

จดทะเบียนก่อตั้ง
บริษัท ทริเพาไพร์ ไม้จริง จำกัด

2004

คิดค้นหาวิธีทดแทน
การใช้ไม้จริง

2005

ติดตั้งเครื่องจักร
Poly Styrene
เทคโนโลยีจากเกาหลี

2006

ผลิตไม้เส้นด้วยวัสดุ
Poly Styrene
อย่างเต็มรูปแบบ

2010

พัฒนาผลิตภัณฑ์
จากไม้กรอบรูปเป็นไม้บัว

2017

ขยายฐานลูกค้า
ไปยังโครงการหมู่บ้าน
และ OEM สินค้า

2020

ก่อตั้งบริษัท
ซัน วู โพลี จำกัด
เพื่อขยายการผลิต

วิสัยทัศน์

//

เรามุ่งมั่นในการทำให้บ้าน และอาคาร
ในอุดมคติของทุกคนเป็นจริงผ่านการตกแต่ง
ทั้งภายนอก และภายใน

//

พันธกิจ

//

ออกแบบ และพัฒนารูปแบบสี และลวดลาย
ของผลิตภัณฑ์ตกแต่งอาคาร เพื่อตอบสนองความต้องการ
ที่แตกต่างกันทั้งภายในประเทศ และอาเซียน

//

บริษัทในเครือ



ผลิตชิ้นส่วนตกแต่งบ้านทดแทนไม้
จากวัสดุพอลิโอสไตรีน

ทุนจดทะเบียน 80,000,000 บาท



ผลิตชิ้นส่วนตกแต่งบ้านทดแทนไม้
จากวัสดุพอลิโอสไตรีน

ทุนจดทะเบียน 15,000,000 บาท



นำเข้า HOT STAMPING FOIL
คุณภาพดีจากประเทศญี่ปุ่น

ทุนจดทะเบียน 3,000,000 บาท



MATERIALS

วัตถุดิบสำคัญ



Polystyrene (Ps)

เม็ดพลาสติก พอลิสไตรีน

ด้วยกระบวนการมาตรฐานจากผู้ผลิตในประเทศไทย



Hot Stamping Foil

พอยล์คุณภาพสูงที่ผ่านการ

คัดสรร เพื่อความทนทานของผลิตภัณฑ์

PROPERTY

คุณสมบัติ

ไม้บัวโพลีคืออะไร

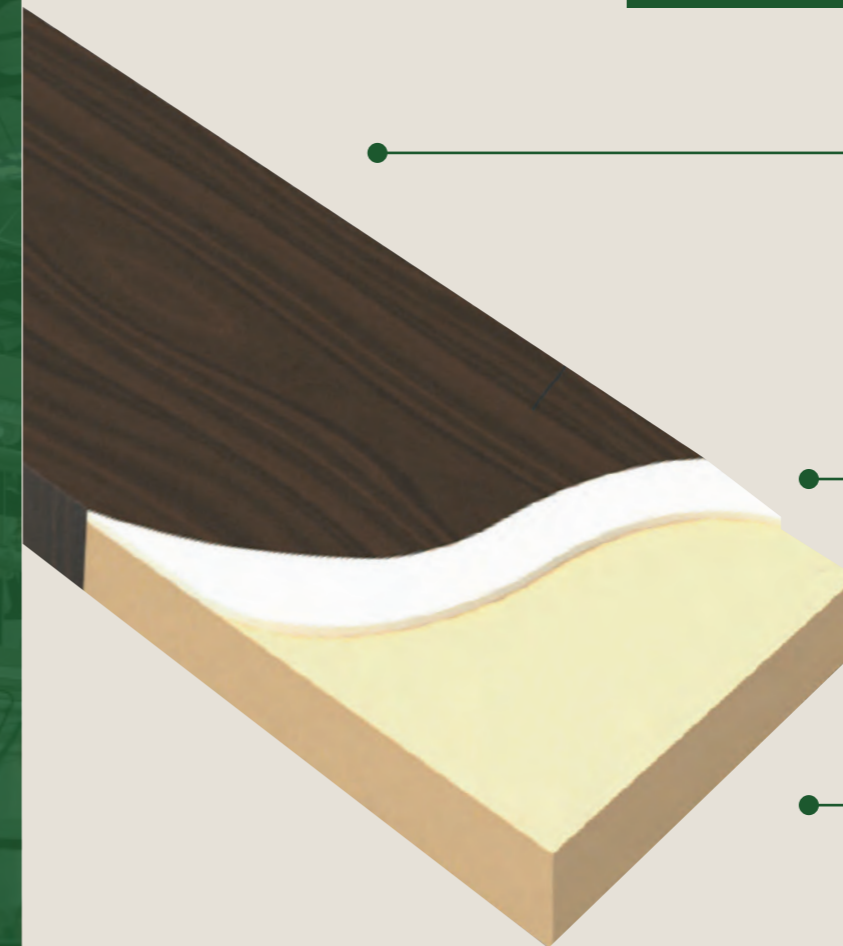

Hot Stamping Foil

ปิดผิวด้วย Hot Stamping Foil
เลียนแบบลายไม้ธรรมชาติ

Hips

เคลือบพลาสติกสูตรหนาพิเศษเพื่อ
ผิวที่เรียบพิมพ์ลายได้สวยงาม

Polystyrene

ชั้นในผลิตจากพลาสติก PS กันน้ำ
น้ำหนักเบา แข็งแรง กันปลวก



กันน้ำ

ไม่วม และโก่งงอ



กันปลวก

กันปลวก / แมลง



ติดตั้งง่าย

ทำงานเหมือนไม้จริง



น้ำหนักเบา

ขนย้ายได้สะดวก



ทนทาน

ทำความสะอาดง่าย

PS / PVC

ต่างกันอย่างไร

FROM SCRAP TO PRODUCT



PS

ลักษณะ : เป็นเส้นตันตลอดทั้งเส้น
 ลวดลาย : ใช้ความร้อนในการพิมพ์ฟอยล์
 ลงบนสินค้า/กลึงพื้นผิวเพิ่มได้
 การซึมน้ำ : ไม่ซึมน้ำ และความชื้น
 การเข้ามุม : ใช้งานเสมื่อนไม้



PVC

ลักษณะ : กลวงเป็นโพล่งตลอดทั้ง เส้น
 ลวดลาย : ใช้กาวในการติดลายลงบนสินค้า
 การซึมน้ำ : ดูดซึมน้ำสูง
 การเข้ามุม : ต้องใช้ตัวเข้ามุมในการประกอบ

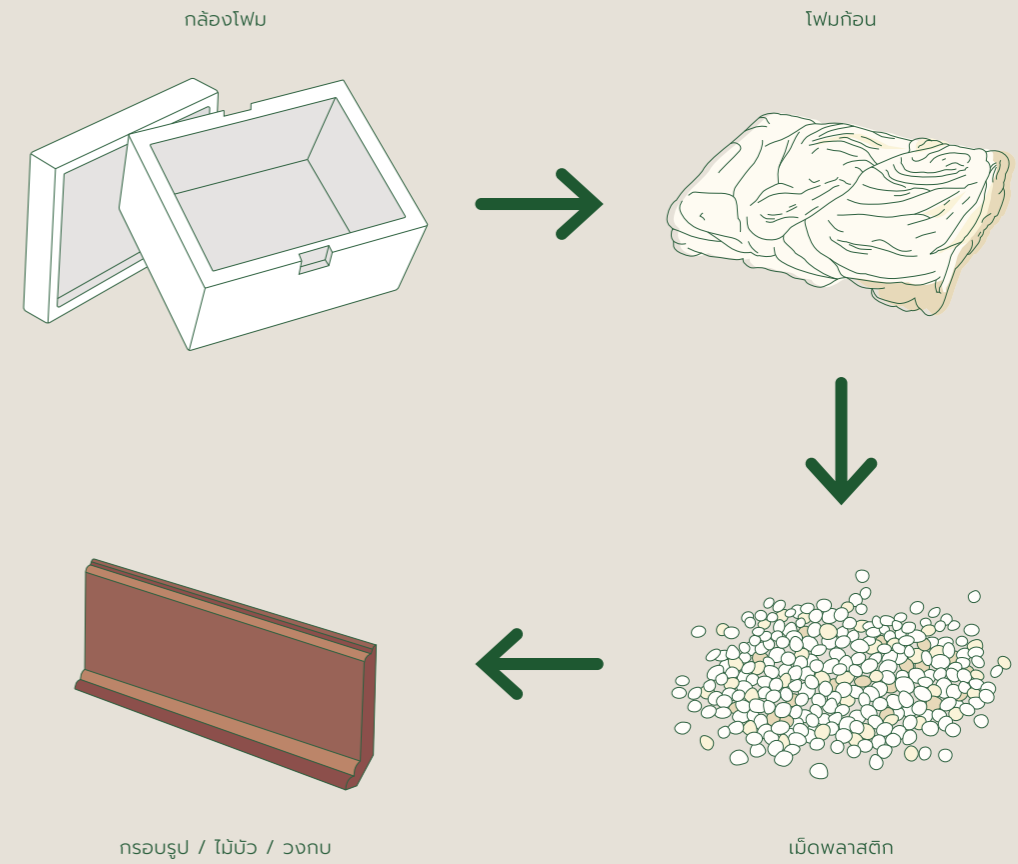

ในปัจจุบันประเทศไทยสร้างขยะพลาสติก 8,400 ตันต่อวัน โดยใช้กล่องโฟมเพื่อบรรจุอาหารเฉลี่ยวันละ 138 ล้านกล่อง ซึ่งทำให้เกิดขยะพลาสติกจำนวนมหาศาลต่อวัน ขยะพลาสติกนั้นเป็นขยะที่ย่อยสลายได้ยากโดยใช้เวลามากกว่า 450 ปีในการย่อยสลาย ทำให้การกำจัดขยะพลาสติกนั้นเป็นเรื่องที่ยาก การรีไซเคิลนั้นจึงเป็นอีกทางเลือกหนึ่งที่จะช่วยลดปัญหาขยะพลาสติกได้

ทางบริษัท ชัน ู โพลี จำกัด ได้นำโฟมที่เกิดจากการหลอมขยะพลาสติกเพื่อนำกลับมาแปรรูปใหม่เป็นผลิตภัณฑ์ต่างๆ เช่น กรอบรูป, ไม้บัว หรือวงกบ โดยเราได้ใช้โฟมรีไซเคิลนี้มากถึง 900 ตันต่อปี เทียบเท่ากับกล่องโฟมใส่อาหาร 180,000,000 กล่อง

ทางบริษัทต้องการที่จะเป็นส่วนหนึ่งในการลดปัญหาขยะพลาสติก และภาวะโลกร้อน เพื่อรักษาสภาพแวดล้อมให้ยืนยาวเพื่อปัจจุบันและคนรุ่นหลังต่อไป

PRODUCTION

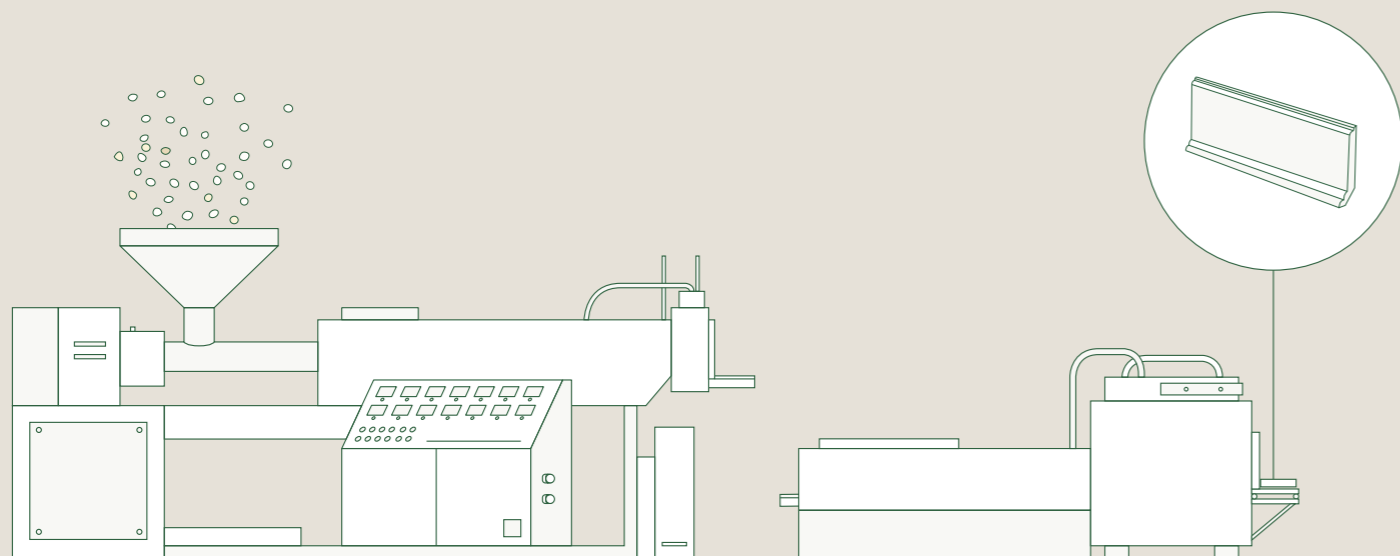

1

การผสมเม็ดพลาสติกด้วยสูตรพิเศษของทางบริษัท ที่ผ่านขั้นตอนวิจัย และทดลองจดบันทึกคุณภาพของชิ้นงาน เพื่อความเที่ยงตรงและ ได้มาตรฐาน

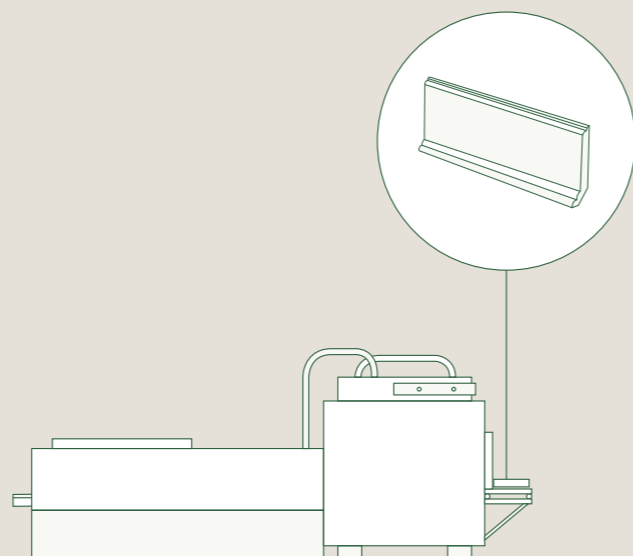

2

การรีดพลาสติกเราใช้เครื่องจักรที่มีคุณภาพ มีเจ้าหน้าที่ชำนาญการควบคุมเครื่องอยู่ตลอดเวลา เพื่อให้รูปทรงของงานออกมาตรงตามแบบ

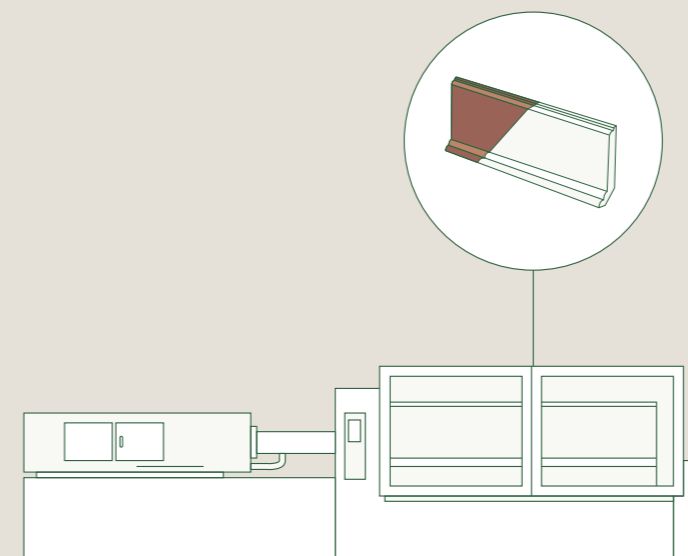

3

การพิมพ์พอยล์เป็นขั้นตอนการให้ความร้อนชิ้นงานก่อนพิมพ์พอยล์ลงบนผิวงาน บริษัทคัดเลือกพอยล์ที่มีคุณภาพ และการควบคุมอุณหภูมิให้สมดุลเพื่อสีชิ้นงานตรงตามที่ลูกค้าต้องการที่สุด

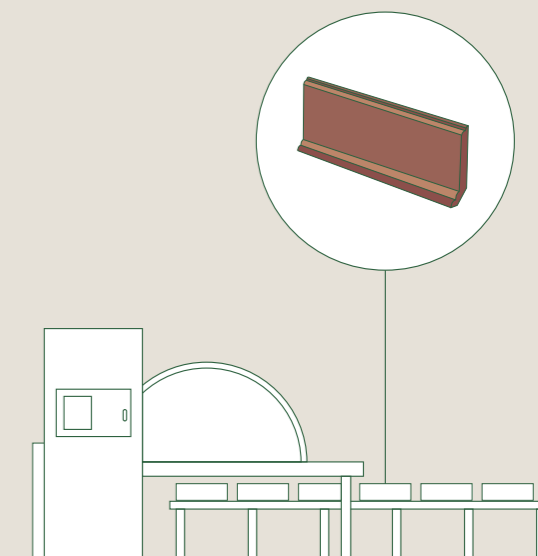

4

การตัดชิ้นงานบริษัทใช้เซนเซอร์ในการตัดชิ้นงาน ทำให้ขนาดทุกชิ้นเท่ากัน ลูกค้าสามารถกำหนดความยาวของชิ้นงานได้

R&D

ทีมวิจัย และพัฒนา

เราให้ความสำคัญกับการศึกษา
และวิจัยผลิตภัณฑ์อย่างต่อเนื่อง
เพื่อปรับปรุง และพัฒนาสินค้า
ให้ตอบโจทย์ตรงตามความต้องการ
ของลูกค้ามากที่สุด

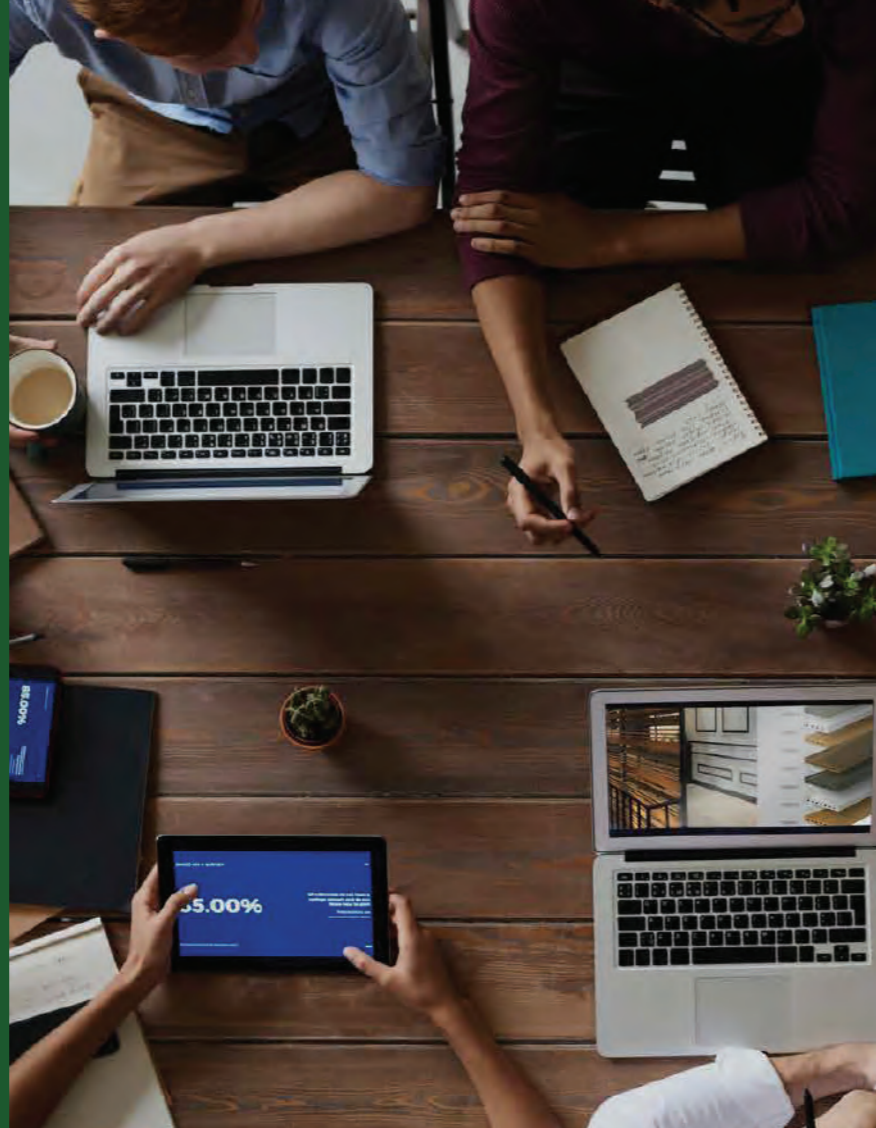

WAREHOUSE

คลังสินค้า

เราให้ความสำคัญกับการจัดการ
คลังสินค้าด้วยการนำเทคโนโลยีเข้าช่วย
ในการตรวจเช็คอย่างสม่ำเสมอ
เพื่อให้การจัดส่งสินค้าให้ลูกค้า
เกิดข้อผิดพลาดน้อยที่สุด



MOULD DEPARTMENT

แม่พิมพ์

บริษัทเรามีทีมพัฒนาแม่พิมพ์เพื่อ
ตอบสนองความต้องการ
ของลูกค้าในระยะเวลารวดเร็ว

PRODUCTION

การผลิต

เราให้ความสำคัญกับการผลิต
ด้วยการนำ เทคโนโลยีที่ทันสมัย
เพื่อให้ผลิตภัณฑ์ได้มาตรฐาน
และเกิดความเสียหายน้อยที่สุด



PRODUCT OVERVIEW

ภาพรวมผลิตภัณฑ์



บัวมอบ
BM-1344

บัววงกบ
BG-870
BG-846

บัวผนัง
BM-1344



บัวระแนง
BG-1662

วงกบ
VK-90200

บัวบน

BB-2100 BB-2277 BB-2288 BB-2270

บัวมุมใน

BG-242 BG-121

บัวมุมนอก

BG-2330 BG-1330



บัวคิ้ว

BK-133

บัวล่าง

BL-912 BL-991
BL-1198 BL-1390



02

Door Frame

ວັງກຸໂຟລີ້

DOOR FRAME

วงกบโพลี

//

ตัด เจาะ ใส ได้เหมือนจริง
ขนาดได้มาตรฐานจบงานในตัวเดียว

//

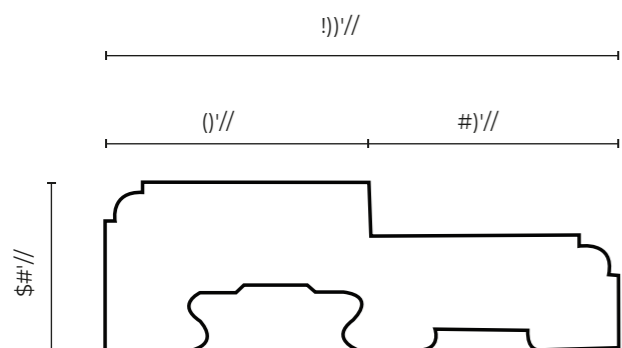
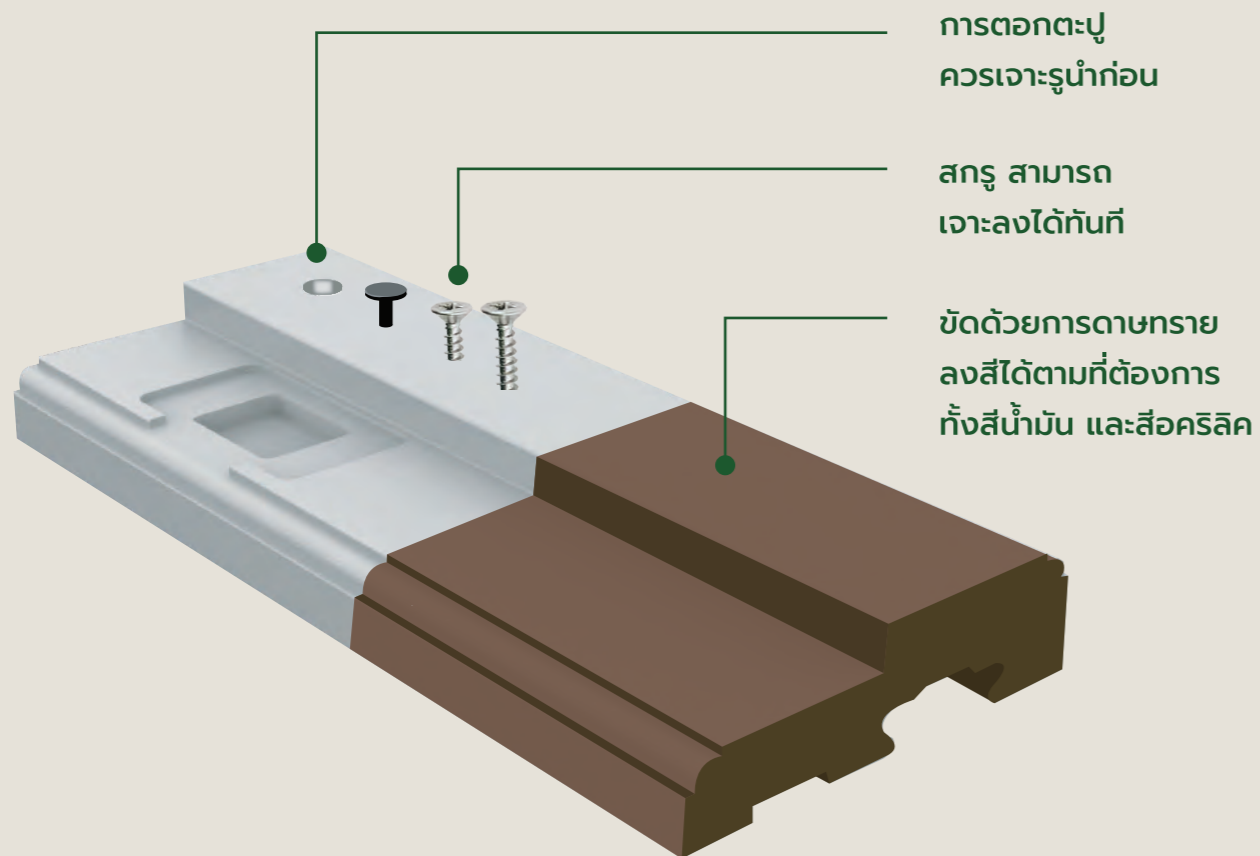

สั่งตัดได้ตามขนาดที่ต้องการ

%&!()")	!(0'-'")'./
%&!))")	!)'-")'./
%&*)")	*')-'")'./
%&'+'")	+)'-'")'./
%&'+'!+)	+)-!+'.'./
%&'!)"	,)'-'")'./
%&'!+)	,)'-'+'.'./





03

Mouldings
Collection

မိဘိ

CLASSIC UPPER CORNICE

บัวบนแบบคลาสสิค



BB-2100-1 (ไม้โอ๊ค) BB-2100-2 (ไม้แดง) BB-2100-3 (ไม้มะค่า) BB-2100-4 (ไม้สักอ่อน) BB-2100-5 (ขาว)



BB-2100-6 (ดำ) BB-2100-7 (ไม้บีช) BB-2100-8 (ไม้เมเปิ้ล) BB-2100-9 (ไม้โอ๊คเข้ม) BB-2100-10 (ไม้สักเข้ม)



BB-2100-11 (ไม้พยูง) BB-2100-13 (ไม้สักทอง)

CLASSIC UPPER CORNICE



BB-2277-1 (ไม้โอ๊ค) BB-2277-2 (ไม้แดง) BB-2277-3 (ไม้มะค่า) BB-2277-4 (ไม้สักอ่อน) BB-2277-5 (ขาว)



BB-2277-6 (ดำ) BB-2277-7 (ไม้บีช) BB-2277-8 (ไม้เมเปิ้ล) BB-2277-9 (ไม้โอ๊คเข้ม) BB-2277-10 (ไม้สักเข้ม)



BB-2277-11 (ไม้พยูง) BB-2277-13 (ไม้สักทอง)

ขนาด



26 เส้น : 1 กล่อง
1 เส้น : 3

BB - 2100



ขนาด

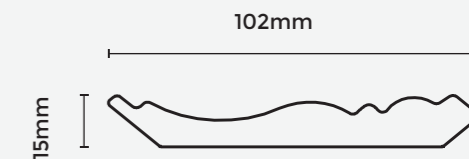

20 เส้น : 1 กล่อง
1 เส้น : 3 เมตร

BB - 2277

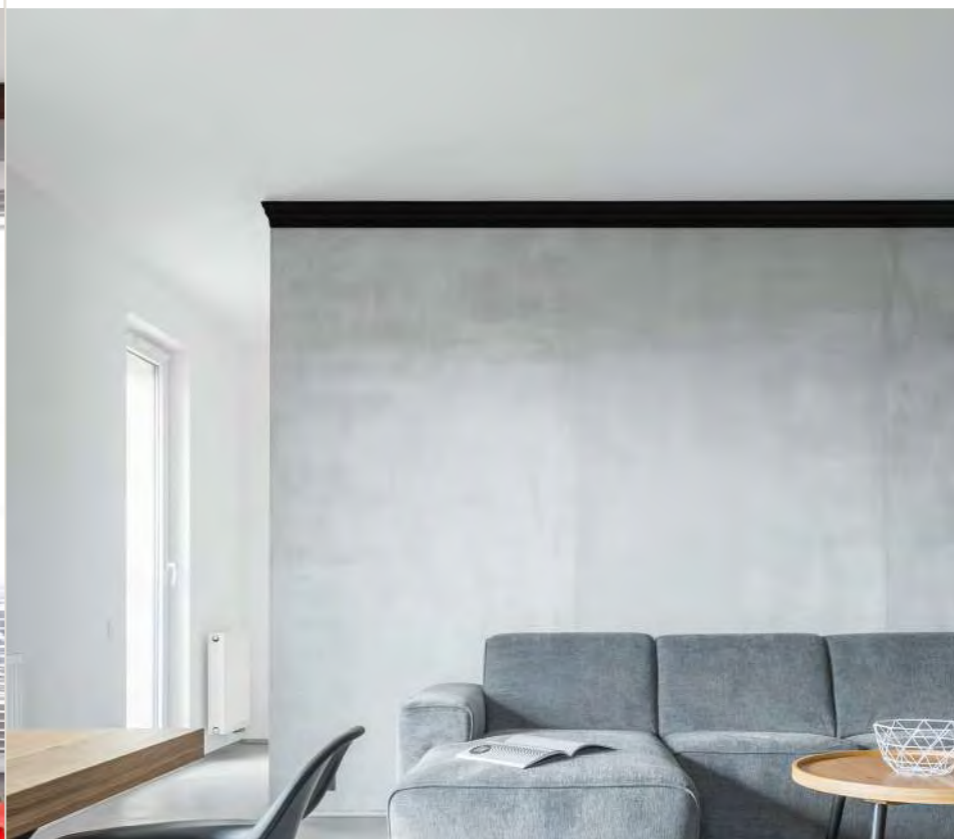
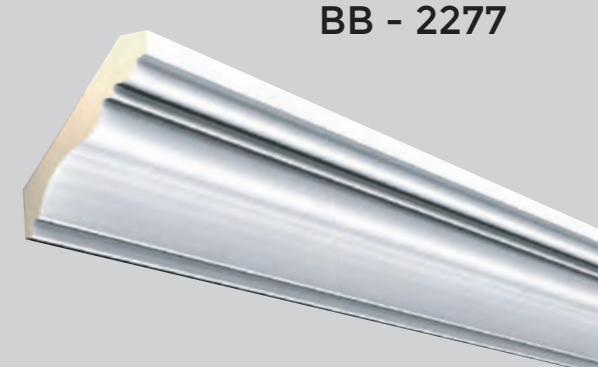

CLASSIC UPPER CORNICE

บัวบนแบบคลาสสิค



BB-2270-1 (ไม้โอ๊ค)



BB-2270-2 (ไม้แดง)



BB-2270-3 (ไม้มะค่า)



BB-2270-4 (ไม้สักอ่อน)



BB-2270-5 (ขาว)

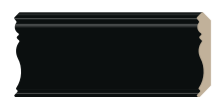

BB-2270-6 (ดำ)



BB-2270-7 (ไม้ชิง)



BB-2270-8 (ไม้เมเปิ้ล)



BB-2270-9 (ไม้โอ๊คเข้ม)



BB-2270-10 (ไม้สักเข้ม)



BB-2270-11 (ไม้พยูง)



BB-2270-13 (ไม้สักทอง)

ขนาด

69mm

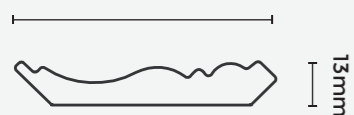

35 เส้น : 1 กล่อง
1 เส้น : 3

BB - 2270



CLASSIC UPPER CORNICE

บัวบนแบบคลาสสิค



BB-2288-1 (ไม้โอ๊ค)



BB-2288-2 (ไม้แดง)



BB-2288-3 (ไม้มะค่า)



BB-2288-4 (ไม้สักอ่อน)



BB-2288-5 (ขาว)

ขนาด

69mm

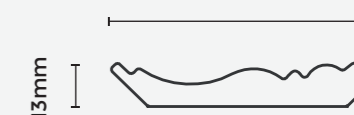

35 เส้น : 1 กล่อง
1 เส้น : 3 เมตร

BB - 2288

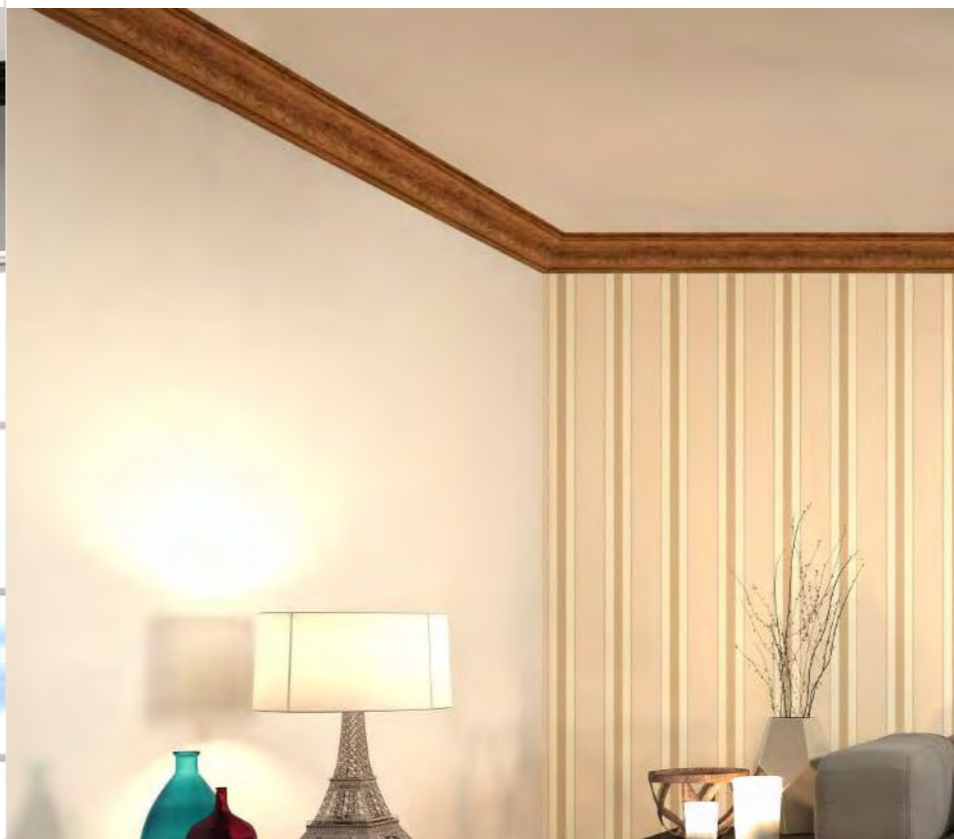

CLASSIC UPPER CORNICE

บัวบนแบบคลาสสิค



BL-991-1 (ไม้โอ๊ค) BL-991-2 (ไม้แดง) BL-991-3 (ไม้เมค้ำ) BL-991-4 (ไม้สักอ่อน) BL-991-5 (ขาว)



BL-991-6 (ดำ) BL-991-7 (ไม้บีช) BL-991-8 (ไม้เมเปิ้ล) BL-991-9 (ไม้โอ๊คเข้ม) BL-991-10 (ไม้สักเข้ม)

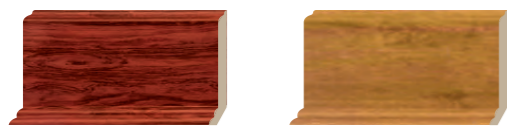

BL-991-11 (ไม้พยูง) BL-991-13 (ไม้สักทอง)

CLASSIC UPPER CORNICE



BL-1198-1 (ไม้โอ๊ค) BL-1198-2 (ไม้แดง) BL-1198-3 (ไม้เมค้ำ) BL-1198-4 (ไม้สักอ่อน) BL-1198-5 (ขาว)



BL-1198-6 (ดำ) BL-1198-7 (ไม้บีช) BL-1198-8 (ไม้เมเปิ้ล) BL-1198-9 (ไม้โอ๊คเข้ม) BL-1198-10 (ไม้สักเข้ม)



BL-1198-11 (ไม้พยูง) BL-1198-13 (ไม้สักทอง)

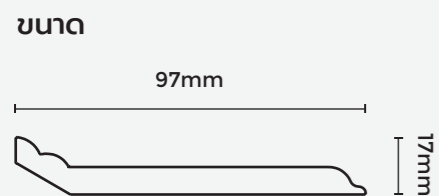

ขนาด
28 เส้น : 1 กล่อง
1 เส้น : 3 เมตร

BB - 2100

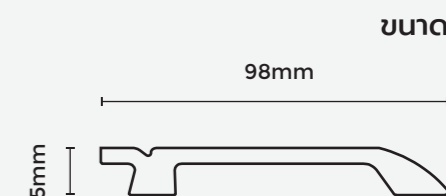
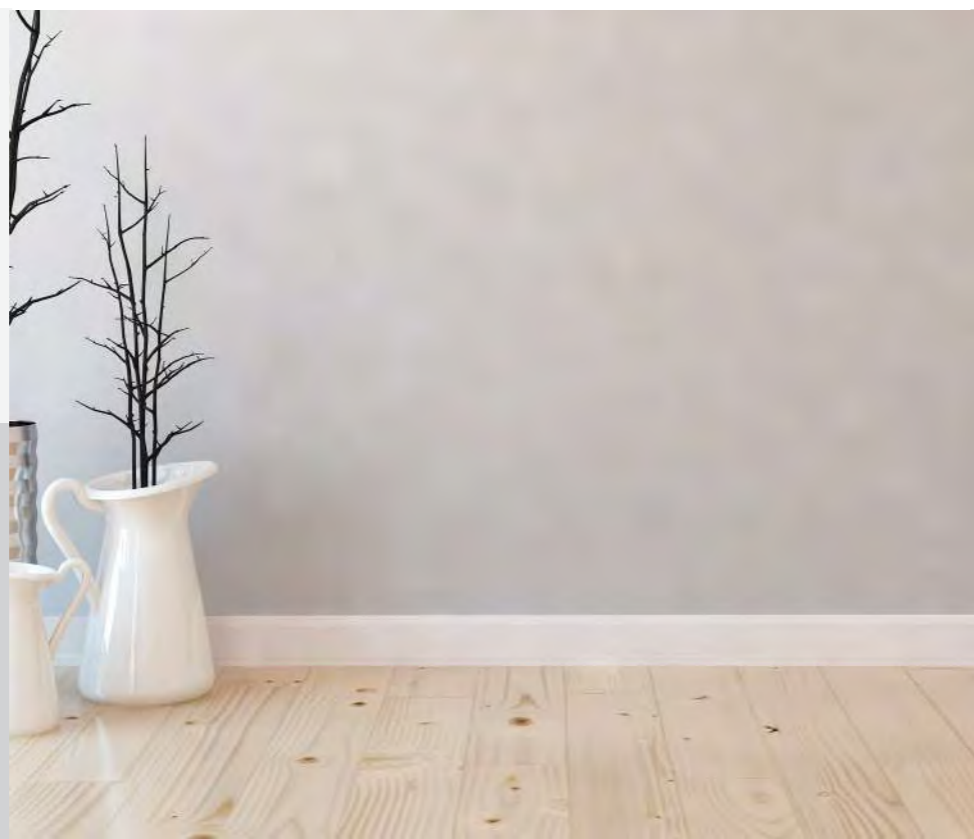

ขนาด
22 เส้น : 1 กล่อง
1 เส้น : 3 เมตร

BL - 1198



CLASSIC UPPER CORNICE

บัวบนแบบคลาสสิค



BL-1390-1 (ไม้โอ๊ค) BL-1390-2 (ไม้แดง) BL-1390-3 (ไม้มะค่า) BL-1390-4 (ไม้สักอ่อน) BL-1390-5 (ขาว)



BL-1390-6 (ดำ) BL-1390-7 (ไม้บีช) BL-1390-8 (ไม้เมเปิ้ล) BL-1390-9 (ไม้โอ๊คเข้ม) BL-1390-10 (ไม้สักเข้ม)



BL-1390-11 (ไม้พยูง) BL-1390-13 (ไม้สักทอง)

ขนาด

90mm



7mm

42 เส้น : 1 กล่อง
1 เส้น : 3 เมตร

BL - 1390



CLASSIC UPPER CORNICE

บัวบนแบบคลาสสิค



BL-912-1 (ไม้โอ๊ค) BL-912-2 (ไม้แดง) BL-912-3 (ไม้มะค่า) BL-912-4 (ไม้สักอ่อน) BL-912-5 (ขาว)



BL-912-6 (ดำ) BL-912-7 (ไม้บีช) BL-912-8 (ไม้เมเปิ้ล) BL-912-9 (ไม้โอ๊คเข้ม) BL-912-10 (ไม้สักเข้ม)

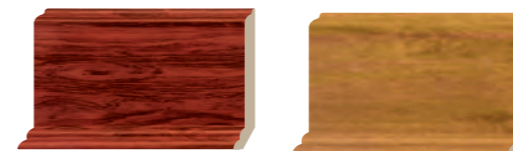

BL-912-11 (ไม้พยูง) BL-912-13 (ไม้สักทอง)

ขนาด

118 mm

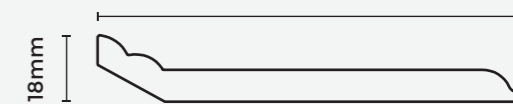

18mm

20 เส้น : 1 กล่อง
1 เส้น : 3 เมตร

BL - 912



CLASSIC UPPER CORNICE

บัวบนแบบคลาสสิค



BL-2330-1 (ไม้โอ๊ค) BL-2330-2 (ไม้แดง) BL-2330-3 (ไม้มะค่า) BL-2330-4 (ไม้สักอ่อน) BL-2330-5 (ขาว)



BL-2330-6 (ดำ) BL-2330-7 (ไม้พยุง) BL-2330-8 (ไม้เมเปิ้ล) BL-2330-9 (ไม้โอ๊คเข้มน) BL-2330-10 (ไม้สักเข้มน)



BL-2330-11 (ไม้พยูง) BL-2330-13 (ไม้สักทอง)

CLASSIC UPPER CORNICE



BL-1330-1 (ไม้โอ๊ค) BL-1330-2 (ไม้แดง) BL-1330-3 (ไม้มะค่า) BL-1330-4 (ไม้สักอ่อน) BL-1330-5 (ขาว)



BL-1330-6 (ดำ) BL-1330-7 (ไม้พยุง) BL-1330-8 (ไม้เมเปิ้ล) BL-1330-9 (ไม้โอ๊คเข้มน) BL-1330-10 (ไม้สักเข้มน)



BL-1330-11 (ไม้พยูง) BL-1330-13 (ไม้สักทอง)

ขนาด

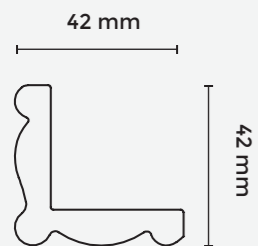

36 เส้น : 1 กล่อง
1 เส้น : 3 เมตร

BG - 2230



ขนาด

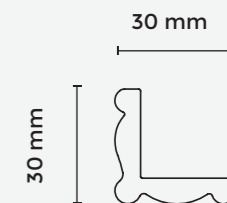

55 เส้น : 1 กล่อง
1 เส้น : 3 เมตร

BG - 1330



CLASSIC UPPER CORNICE

บัวบนแบบคลาสสิค



BG-242-1 (ไม้โอ๊ค)



BG-242-2 (ไม้แดง)



BG-243 (ไม้ระคำ)



BG-242-4 (ไม้สักอ่อน)



BG-242-5 (ขาว)



BG-242-6 (ดำ)



BG-242-7 (ไม้บีช)



BG-242-8 (ไม้เมเปิ้ล)



BG-242-9 (ไม้โอ๊คเข้ม)



BG-242-10 (ไม้สักเข้ม)



BG-242-11 (ไม้พยูง)



BG-242-13 (ไม้สักทอง)



BG-121-1 (ไม้โอ๊ค)



BG-121-2 (ไม้แดง)



BG-121-3 (ไม้ระคำ)



BG-121-4 (ไม้สักอ่อน)



BG-121-5 (ขาว)



BG-121-6 (ดำ)



BG-121-7 (ไม้บีช)



BG-121-8 (ไม้เมเปิ้ล)



BG-121-8 (ไม้โอ๊คเข้ม)



BG-121-10 (ไม้สักเข้ม)



BG-121-11 (ไม้พยูง)



BG-121-13 (ไม้สักทอง)

CLASSIC UPPER CORNICE

บัวบนแบบคลาสสิค

ขนาด

35 mm

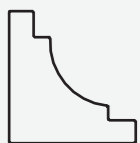

35 mm

36 เส้น 1 กล่อง
1 เส้น : 3 เมตร

BG - 242

ขนาด

24 mm



24 mm

72 เส้น : 1 กล่อง
1 เส้น : 3 เมตร

BG - 121

CLASSIC UPPER CORNICE

บัวบนแบบคลาสสิค



BG-870-1 (ไม้โอ๊ค) BG-870-2 (ไม้แดง) BG-870-3 (ไม้มะค่า) BG-870-4 (ไม้สักอ่อน) BG-870-5 (ขาว)



BG-870-6 (ดำ) BG-870-7 (ไม้บีช) BG-870-8 (ไม้มะเกลือ) BG-870-9 (ไม้โอ๊คเข้ม) BG-870-10 (ไม้สักเข้ม)



BG-870-11 (ไม้พยูง) BG-870-13 (ไม้สักทอง)

CLASSIC UPPER CORNICE



BG-846-1 (ไม้โอ๊ค) BG-846-2 (ไม้แดง) BG-846-3 (ไม้มะค่า) BG-846-4 (ไม้สักอ่อน) BG-846-5 (ขาว)



BG-846-6 (ดำ) BG-846-7 (ไม้บีช) BG-846-8 (ไม้มะเกลือ) BG-846-9 (ไม้โอ๊คเข้ม) BG-846-10 (ไม้สักเข้ม)



BG-846-11 (ไม้พยูง) BG-846-13 (ไม้สักทอง)

ขนาด



24 เส้น : 1 กล่อง
1 เส้น : 3 เมตร

BG - 870



ขนาด

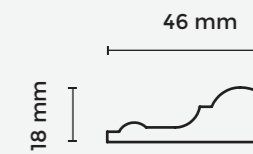

40 เส้น : 1 กล่อง
1 เส้น : 3 เมตร

BG - 846



CLASSIC UPPER CORNICE

บัวบนแบบคลาสสิค



BM-1344-1 (ไม้โอ๊ค) BM-1344-2 (ไม้แดง) BM-1344-3 (ไม้เมะค่า) BM-1344-4 (ไม้สักอ่อน) BM-1344-5 (ขาว)



BM-1344-6 (ดำ) BM-1344-7 (ไม้บีช) BM-1344-8 (ไม้เมเปิ้ล) BM-1344-9 (ไม้โอ๊คเข้ม) BM-1344-10 (ไม้สักเข้ม)



BM-1344-11 (ไม้พยูง) BM-1344-13 (ไม้สักทอง)

ขนาด

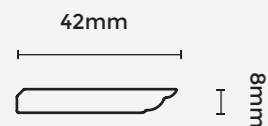

xx เส้น : 1 กล่อง
1 เส้น : 3

BM - 1344

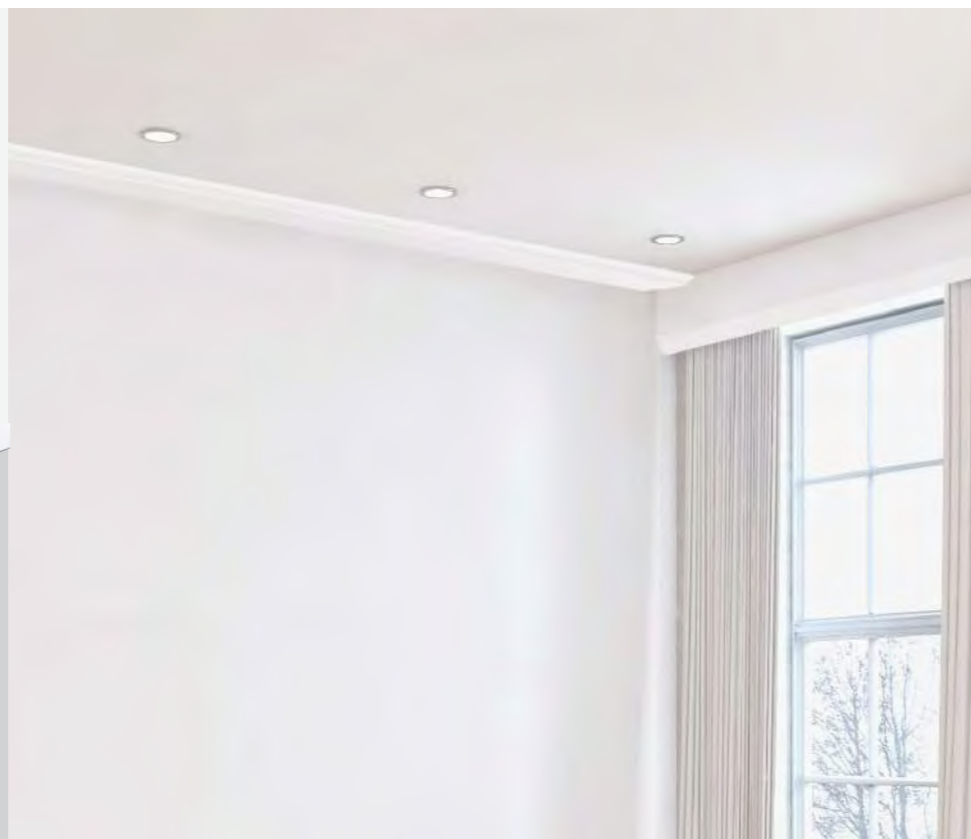

CLASSIC UPPER CORNICE

บัวบนแบบคลาสสิค



BG-1662 - 1 (ไม้โอ๊ค) BG-1662 - 2 (ไม้แดง) BG-1662 - 3 (ไม้เมะค่า) BG-1662 - 4 (ไม้สักอ่อน) BG-1662 - 5 (ขาว)



BG-1662 - 6 (ดำ) BG-1662 - 7 (ไม้บีช) BG-1662 - 8 (ไม้เมเปิ้ล) BG-1662 - 9 (ไม้โอ๊คเข้ม) BG-1662 - 10 (ไม้สักเข้ม)



BG-1662 - 11 (ไม้พยูง) BG-1662 - 13 (ไม้สักทอง)

ขนาด

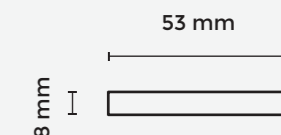

60 เส้น : 1 กล่อง
1 เส้น : 3 เมตร

BG - 1662

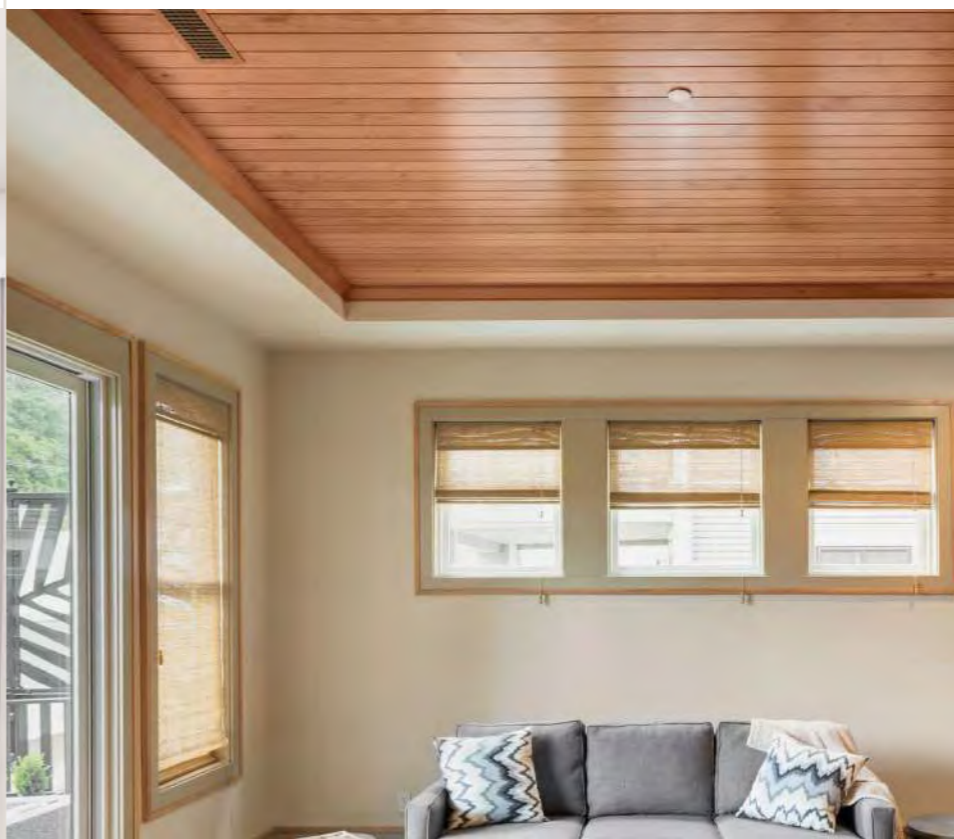

CLASSIC UPPER CORNICE

บัวบนแบบคลาสสิค



BM-2344-1 (ไม้โอ๊ค) BM-2344-2 (ไม้แดง) BM-2344-3 (ไม้เมค้ำ) BM-2344-4 (ไม้สักอ่อน) BM-2344-5 (ขาว)



BM-2344-6 (ดำ) BM-2344-7 (ไม้บีช) BM-2344-8 (ไม้มะเกลือ) BM-2344-9 (ไม้โอ๊คเข้ม) BM-2344-10 (ไม้สักเข้ม)



BM-2344-11 (ไม้พยูง) BM-2344-13 (ไม้สักทอง)

CLASSIC UPPER CORNICE



BK-133-1 (ไม้โอ๊ค) BK-133-2 (ไม้แดง) BK-133-3 (ไม้เมค้ำ) BK-133-4 (ไม้สักอ่อน) BK-133-5 (ขาว)



BK-133-6 (ดำ) BK-133-7 (ไม้บีช) BK-133-8 (ไม้มะเกลือ) BK-133-9 (ไม้โอ๊คเข้ม) BK-133-10 (ไม้สักเข้ม)



BK-133-11 (ไม้พยูง) BK-133-13 (ไม้สักทอง)

ขนาด

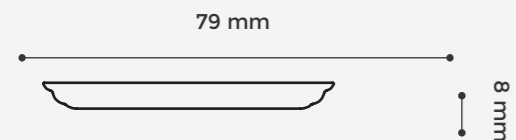

36 เส้น 1 กล่อง
1 เส้น : 3 เมตร

BM - 2344

ขนาด

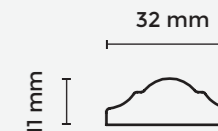

60 เส้น : 1 กล่อง
1 เส้น : 3 เมตร

BK - 133

AABHA COLLECTION

GROUND CORNICE บัวล่าง

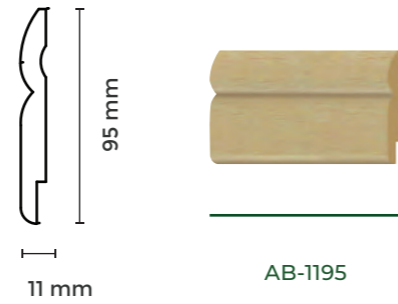
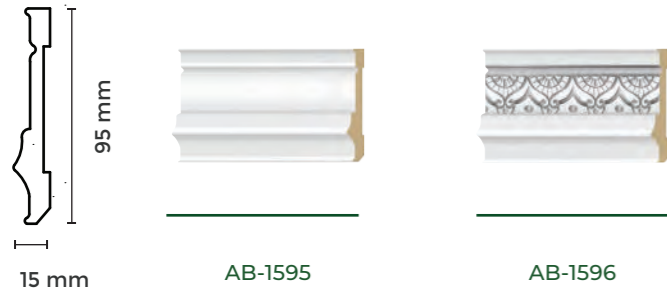

UPPER CORNICE บัวบน



CORNER CORNICE บัวทวาร



FRAME CORNICE บัววงกบ



CORNICE MOLDING บัวคิ้ว



CORNER CORNICE บัวมุมนอก



CORNER CORNICE บัวมุมใน

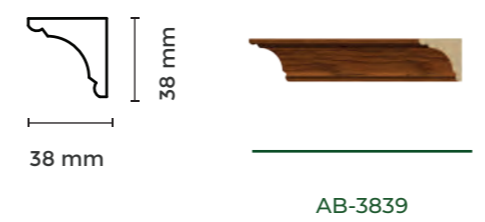

COVER CORNICE บัวมอบ



COLOR OF CORNICE สีไม้บัว



ART DECO COLLECTION

GROUND CORNICE บัวล่าง

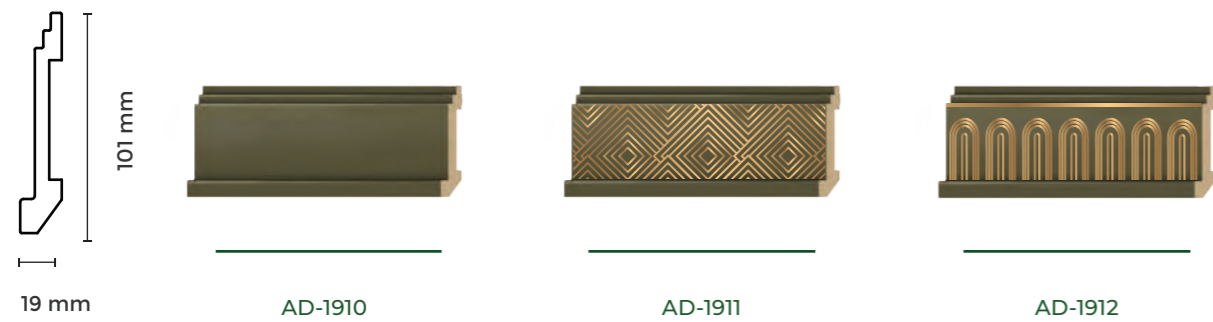
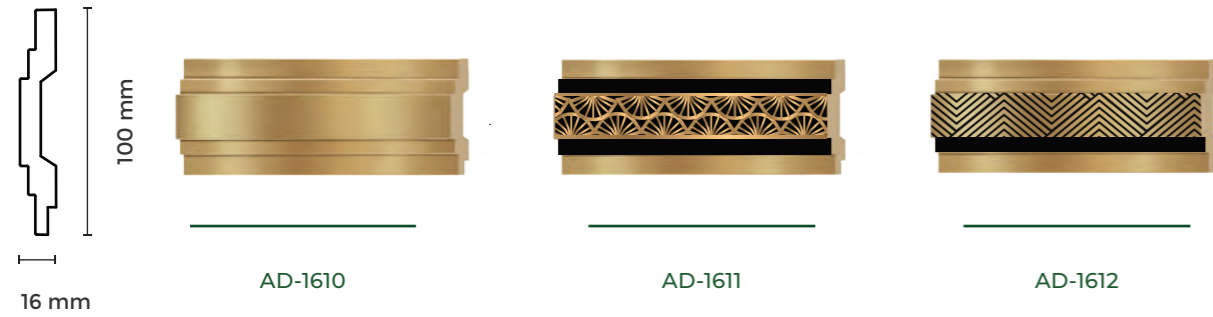

UPPER CORNICE บัวบน



FRAME CORNICE บัววงกบ



CORNICE MOLDING บัวคิ้ว

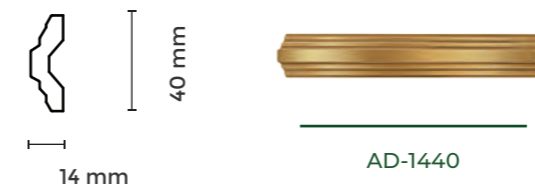

CORNER CORNICE บัวกลาง



CORNER CORNICE บัวมุมนอก

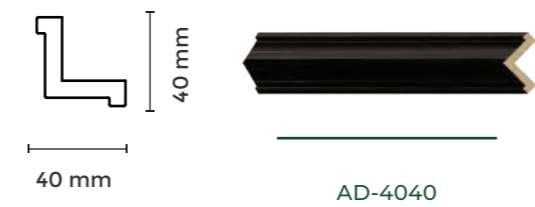

CORNER CORNICE บัวมุมใน

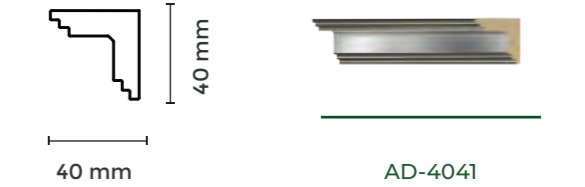

COVER CORNICE บัวมอบ



COLOR OF CORNICE สีไม้บัว

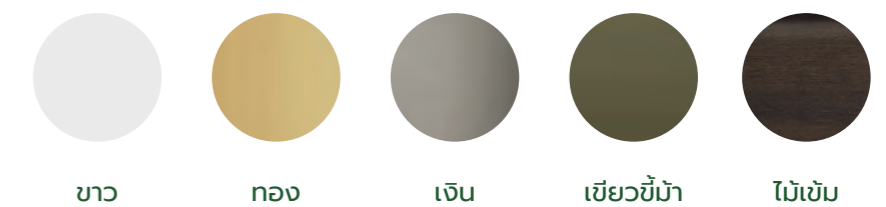

BEI-MU COLLECTION

GROUND CORNICE ប៉ວລ່ាង



UPPER CORNICE ប៉ឺបប

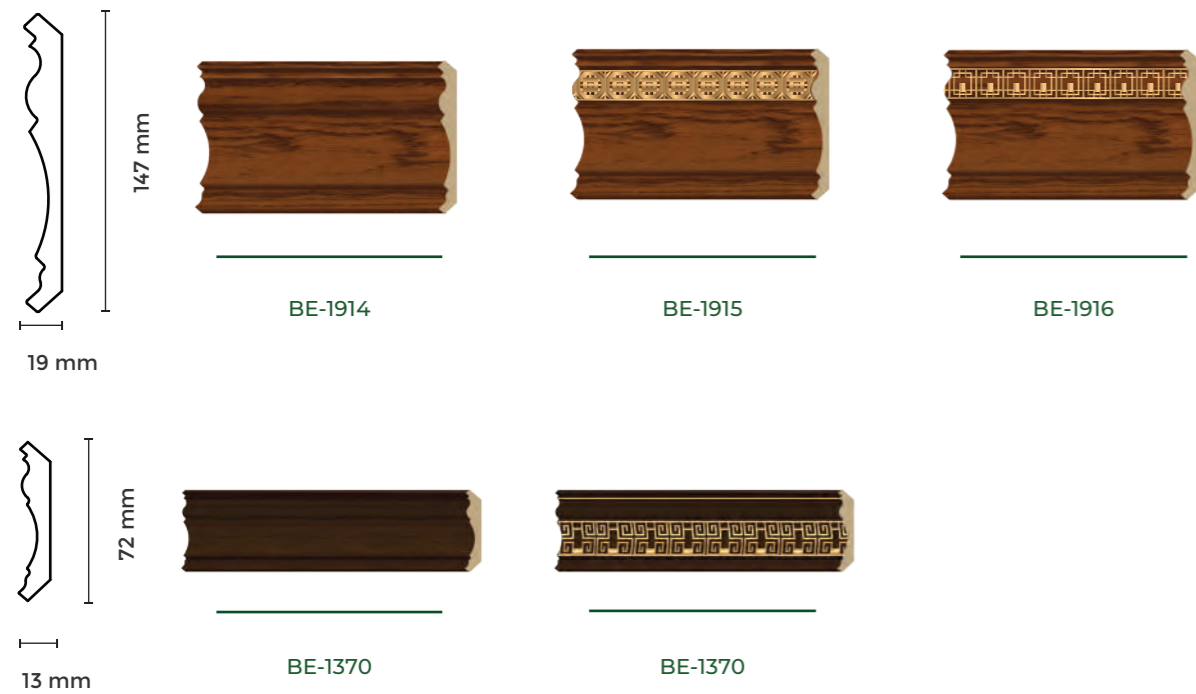

CORNER CORNICE ប៉ឺកតាង

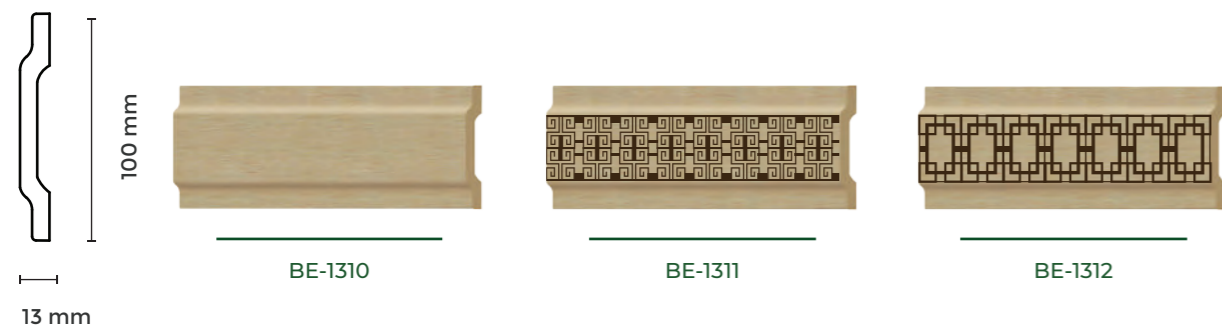

CORNICE MOLDING ប៉ឺកឺវ



FRAME CORNICE ប៉ឺវងកប



CORNER CORNICE ប៉ឺមុំរេក

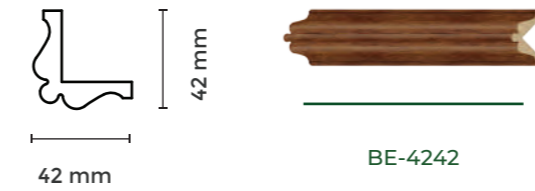

CORNER CORNICE ប៉ឺមុំរេក

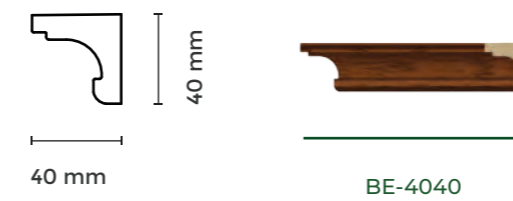

COVER CORNICE ប៉ឺរេក



COLOR OF CORNICE ស្រែប៉ឺ



COLONAIL COLLECTION

GROUND CORNICE ບັວລ່າງ



UPPER CORNICE ບັວໜ



CORNER CORNICE ບັວກລາງ



CORNICE MOLDING ບັວຄົ້ວ



FRAME CORNICE ບັວວງກບ



CORNER CORNICE ບັວມຸມນອກ

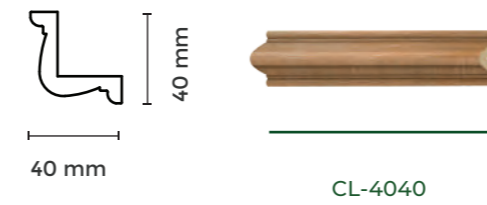

CORNER CORNICE ບັວມຸມໃນ

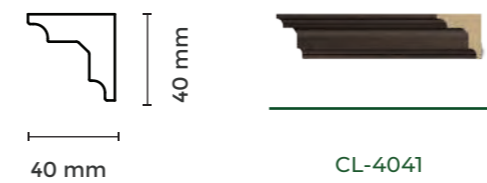

COVER CORNICE ບັວມອບ



COLOR OF CORNICE ສີໄມ້ບັວ



CONTEMPORARY COLLECTION

GROUND CORNICE ບັວລ່າງ

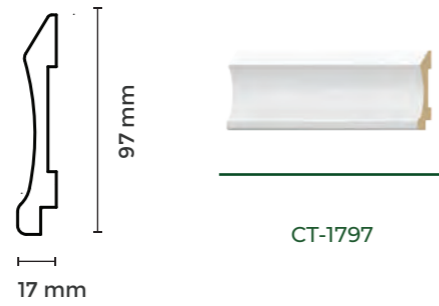
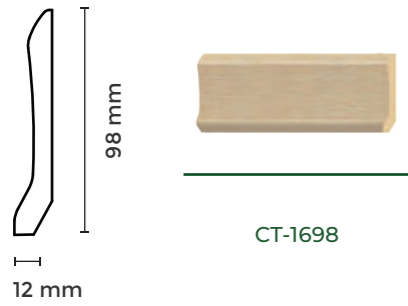

UPPER CORNICE ບັວນນ

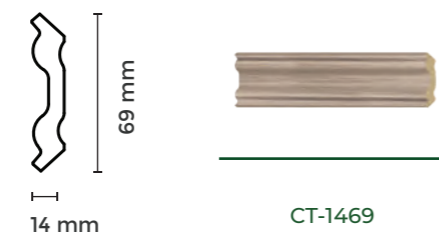
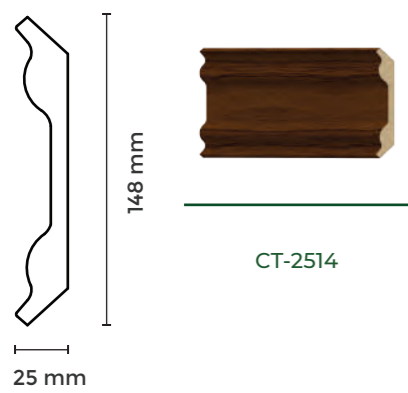

CORNER CORNICE ບັວກລາງ

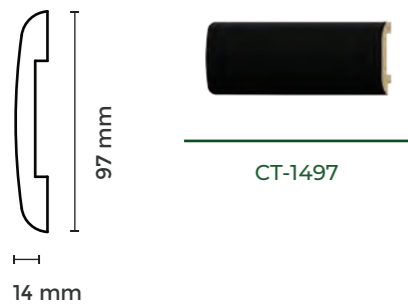

FRAME CORNICE ບັວຈາກບ

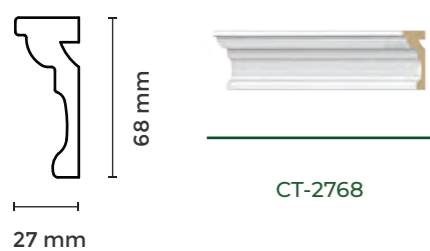

CORNICE MOLDING ບັວຄົ້ວ



CORNER CORNICE ບັວມຸມນອກ

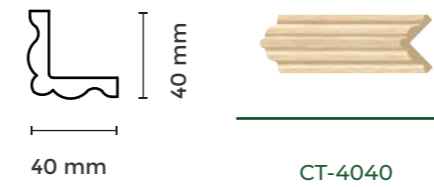

CORNER CORNICE ບັວມຸມໃນ

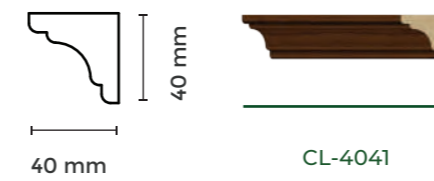

COVER CORNICE ບັວມອບ



COLOR OF CORNICE ສີໄມ້ບັວ



LALAMY COLLECTION

GROUND CORNICE บัวล่าง



UPPER CORNICE บัวบน

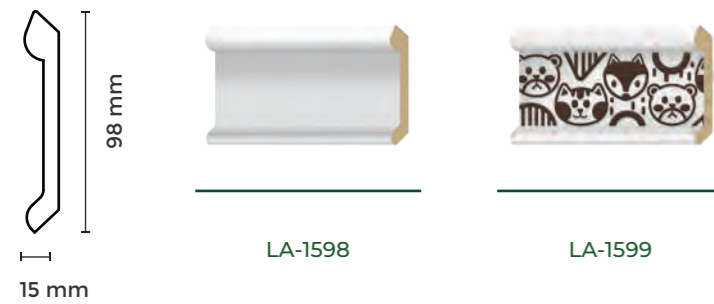

CORNER CORNICE บัวทาลง

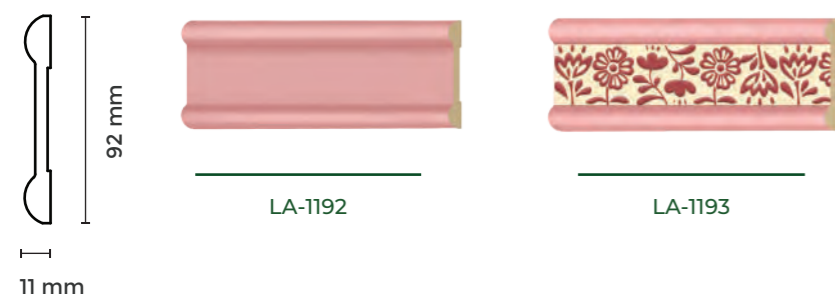

FRAME CORNICE บัววงกบ



CORNICE MOLDING บัวคิ้ว



CORNER CORNICE บัวมุมนอก

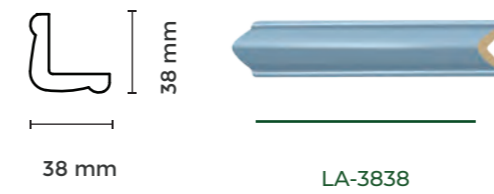

CORNER CORNICE บัวมุมใน

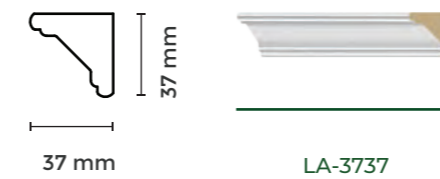

COVER CORNICE บัวมอบ



COLOR OF CORNICE สีไม้บัว

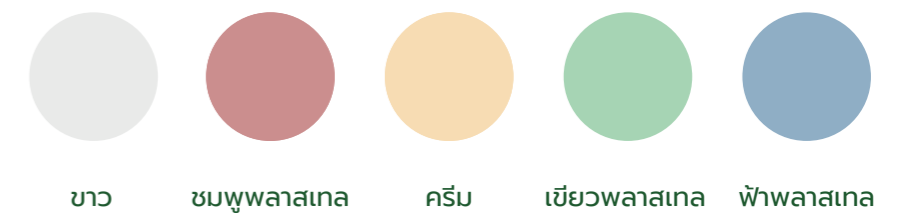

MINIMAL COLLECTION

GROUND CORNICE บัวล่าง

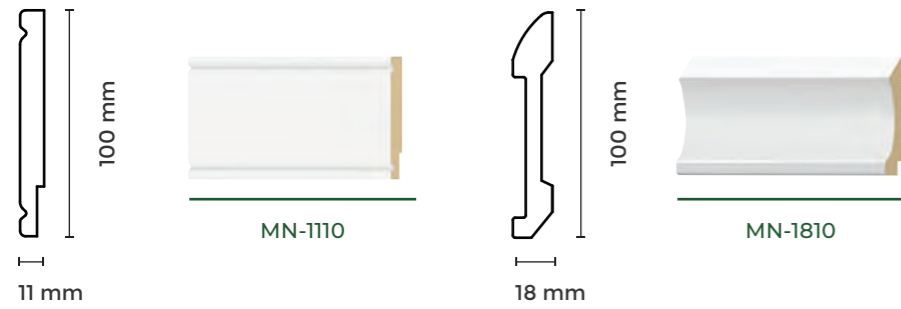

UPPER CORNICE บัวบน

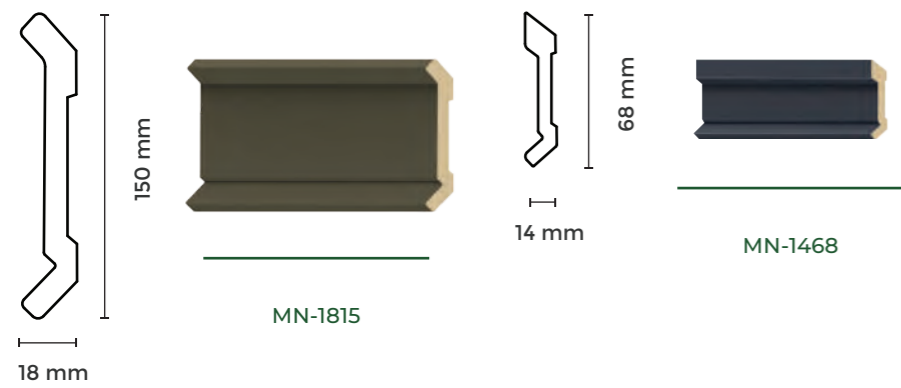

CORNER CORNICE บัวกลาง

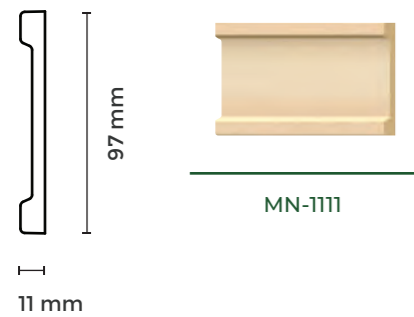

FRAME CORNICE บัววงทศ

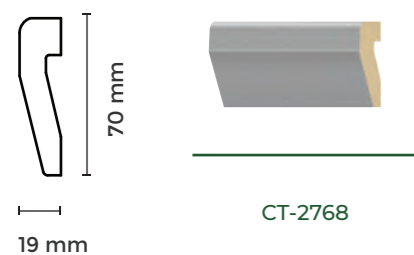

CORNICE MOLDING บัวคิ้ว



CORNER CORNICE บัวมุมนอก

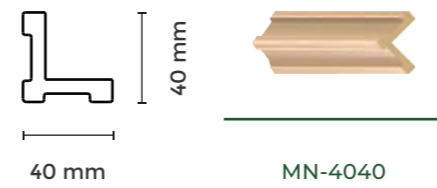

CORNER CORNICE บัวมุมใน

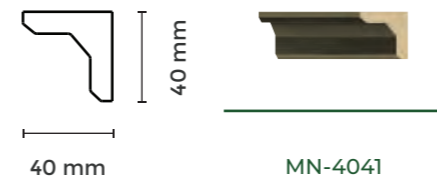

COVER CORNICE บัวมอ



COLOR OF CORNICE สีไม้บัว

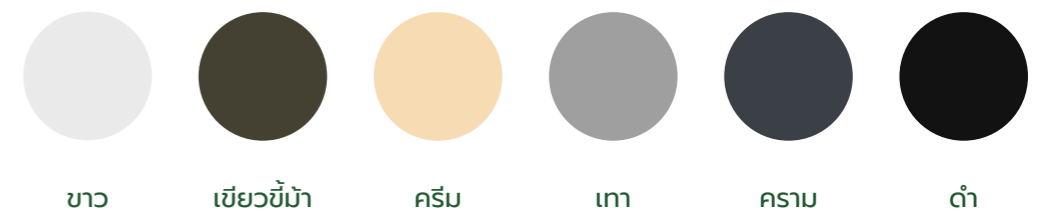

MODERN COLLECTION

GROUND CORNICE ប៉ວລ່ាង

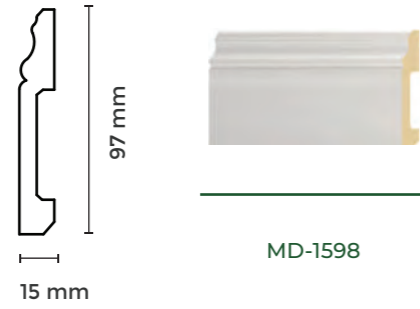
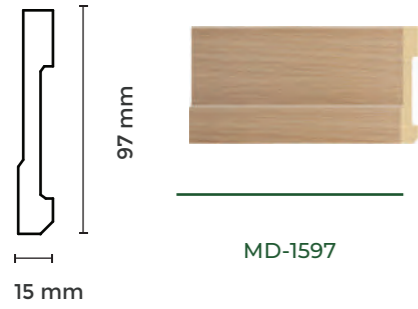

UPPER CORNICE ប៉ឺន

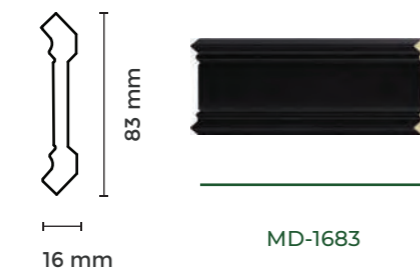
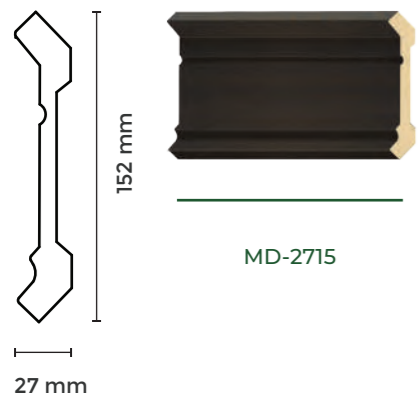

CORNER CORNICE ប៉ឺកតាង

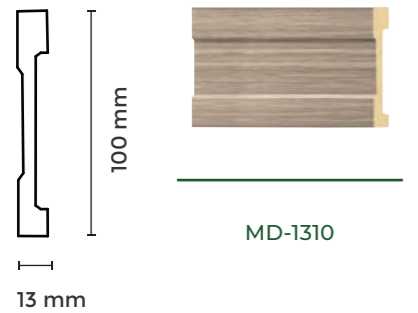

FRAME CORNICE ប៉ឺកតាង



CORNICE MOLDING ប៉ឺកតាង



CORNER CORNICE ប៉ឺកតាង

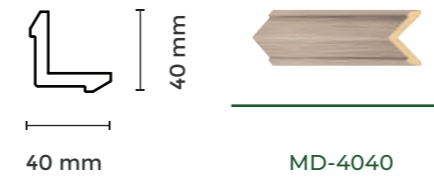

CORNER CORNICE ប៉ឺកតាង

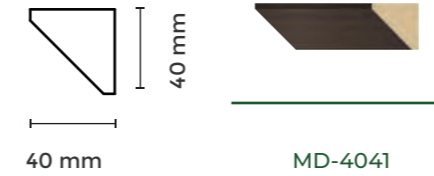

COVER CORNICE ប៉ឺកតាង



COLOR OF CORNICE ស៊ែប៉ឺកតាង



MODERN LUXURY COLLECTION

GROUND CORNICE บัวล่าง

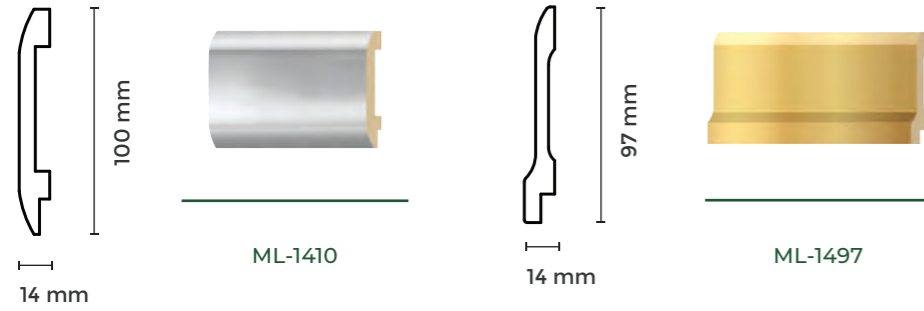

UPPER CORNICE บัวบน

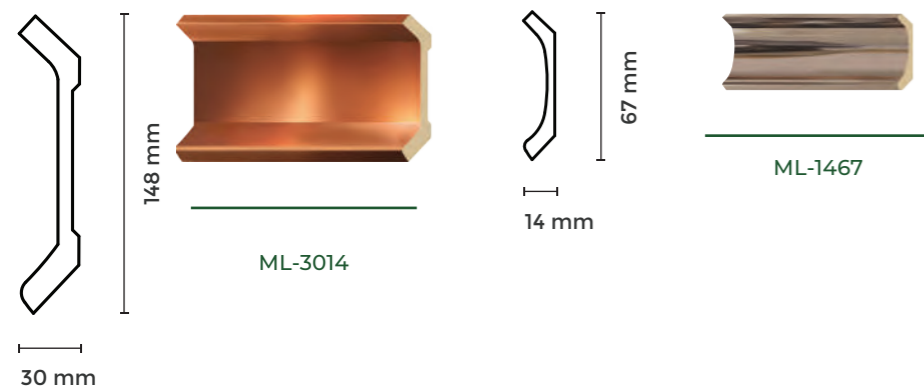

CORNER CORNICE บัวทาลง

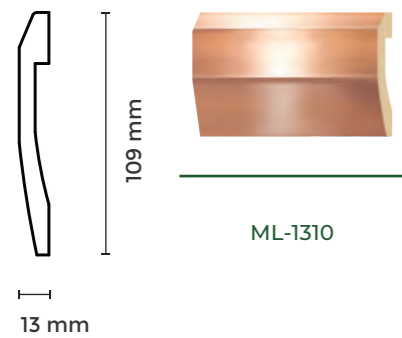

FRAME CORNICE บัววงทาบ

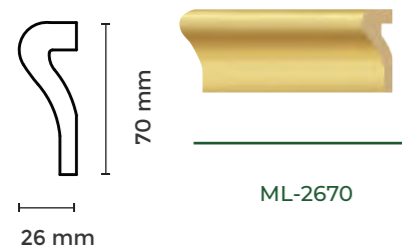

CORNICE MOLDING บัวคิ้ว

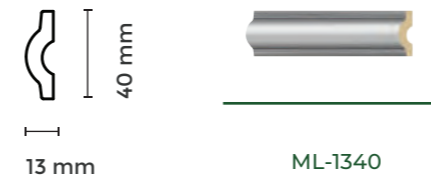

CORNER CORNICE บัวมุมนอก

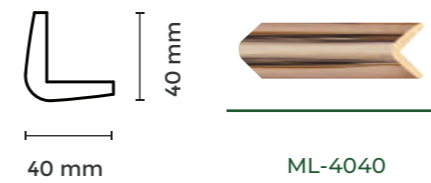

CORNER CORNICE บัวมุมใน

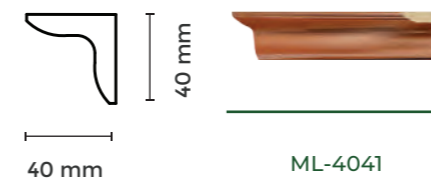

COVER CORNICE บัวมอบ

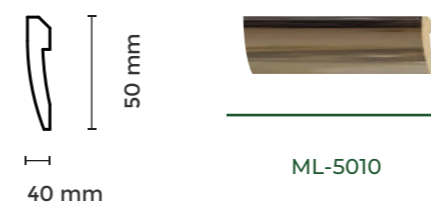

COLOR OF CORNICE สีไม้บัว

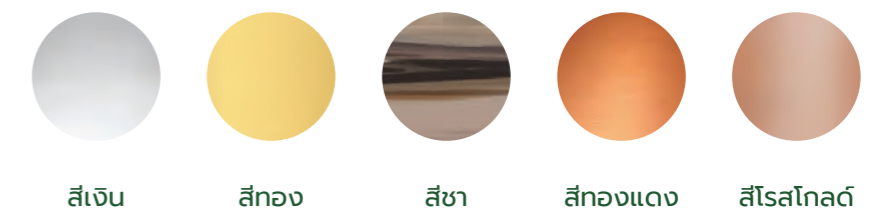

PA-KA-KARN COLLECTION

GROUND CORNICE บัวล่าง

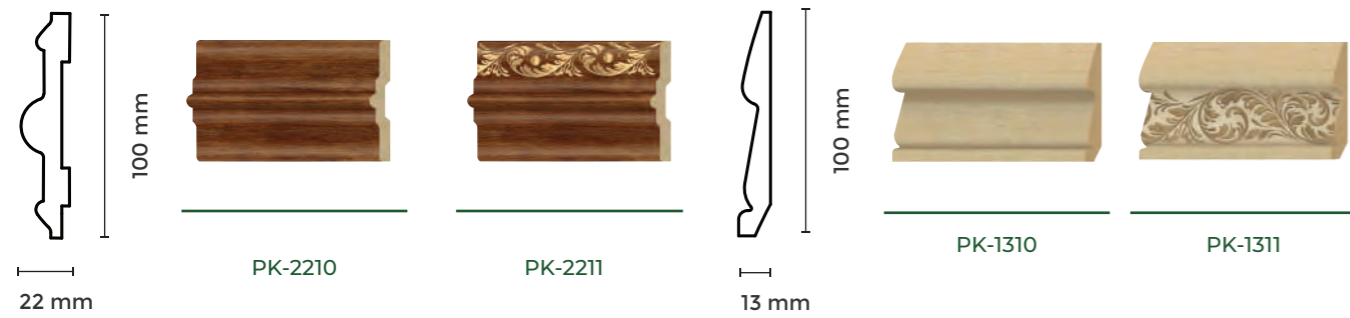

UPPER CORNICE บัวบน

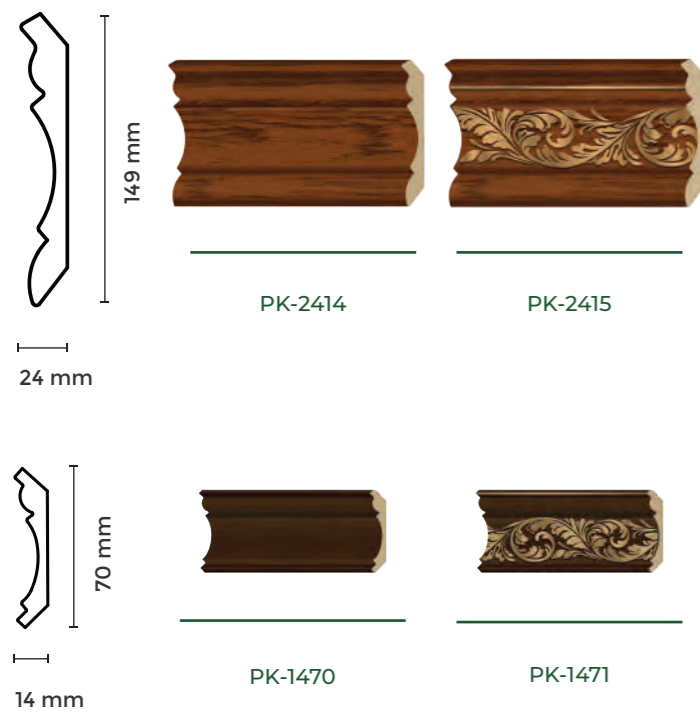

CORNER CORNICE บัวทาลง

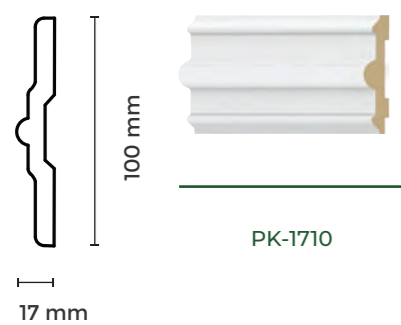

FRAME CORNICE บัวจกท



CORNICE MOLDING บัวคิ้ว



CORNER CORNICE บัวมุมนอก

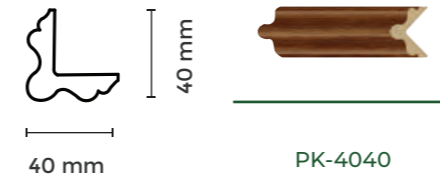

CORNER CORNICE บัวมุมใน

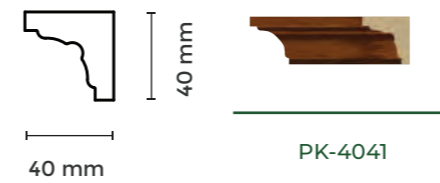

COVER CORNICE บัวมอ

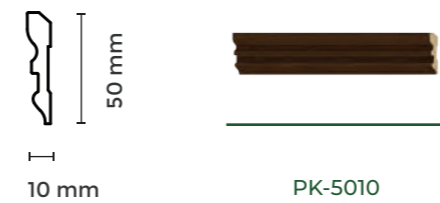

COLOR OF CORNICE สีไม้บัว





04 Picture Frame

ករណីបន្ត

CLASSIC PICTURE FRAME

CLASSIC STYLE – TF-0119

35 mm (1 ប៉ូ 3 អុ)

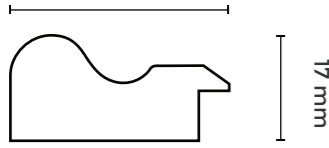

ឧទា : 35 ម. X 17 ម.
1 ក្លែង : 54 ត្រីន (មក 3 ម.)



TF-0119-GS

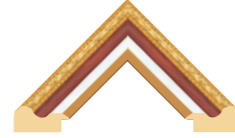

TF-0119-CR



TF-0119-O2

CLASSIC STYLE – TF-0249

33 mm (1 ប៉ូ 2 អុ)

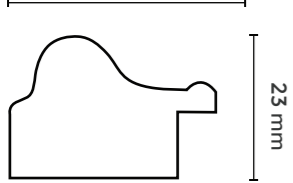

ឧទា : 33 ម. X 23 ម.
1 ក្លែង : 42 ត្រីន (មក 3 ម.)



TF-0249-O3



TF-0249-GS



TF-0249-CR

CLASSIC STYLE – TF-1031

28 mm

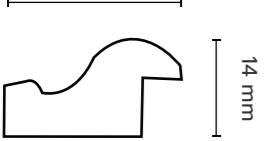

ឧទា : 28 ម. X 14 ម.
1 ក្លែង : 100 ត្រីន (មក 3 ម.)



TF-1031-WC



TF-1031-GM



TF-1031-OR



TF-1031-O3



CLASSIC PICTURE FRAME

CLASSIC STYLE – TF-0145

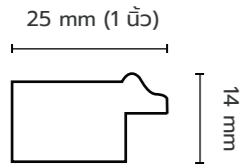

ขนาด : 25 มม. X 14 มม.
1 ก่อ : 81 เส้น (ยาว 3 ม.)

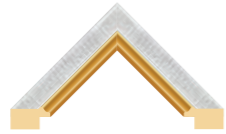

TF-0145-WM



TF-0145-CR



TF-0145-WC



TF-0145-03

CLASSIC STYLE – TF-2021

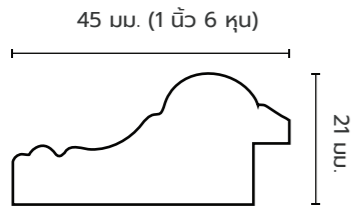

ขนาด : 33 มม. X 23 มม.
1 ก่อ : 42 เส้น (ยาว 3 ม.)



TF-2021-GS



TF-2022-M3

CLASSIC STYLE – TF-2237

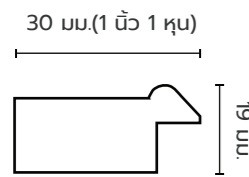

ขนาด : 30 มม. X 19 มม.
1 ก่อ : 72 เส้น (ยาว 3 ม.)

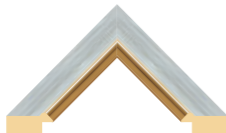

TF-2237-WM



TF-2021-GS

TF-2022-M3



CLASSIC PICTURE FRAME

CLASSIC STYLE – TF-3267

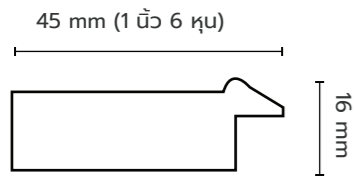

ឆរាម : 45 មម. X 21 មម.
1 ក្រដាស : 40 ទ្រីន (មក 3 ម.)

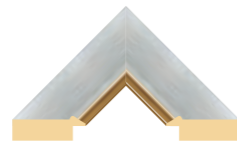

TF-3267-WM

CLASSIC STYLE – TF-0200

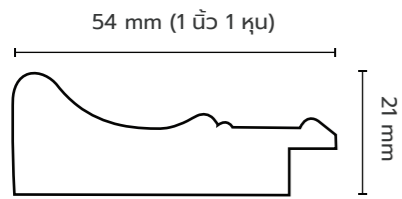

ឆរាម : 25 មម. X 14 មម.
1 ក្រដាស : 81 ទ្រីន (មក 3 ម.)

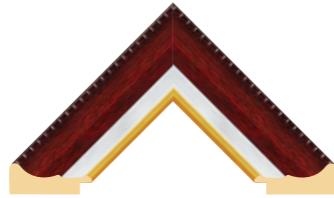

TF-0200-OR



TF-0200-GS



TF-0200-GS1

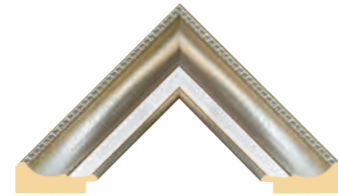

TF-0200-SS

CLASSIC STYLE – TF-2007

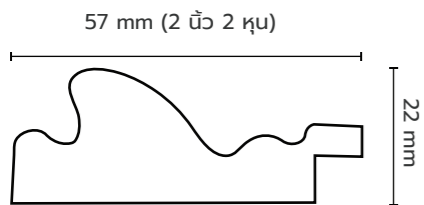

ឆរាម : 57 មម. X 22 មម.
1 ក្រដាស : 28 ទ្រីន (មក 3 ម.)

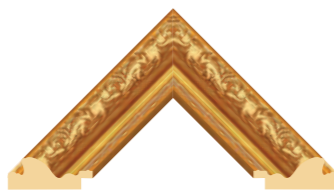

TF-2007-GS

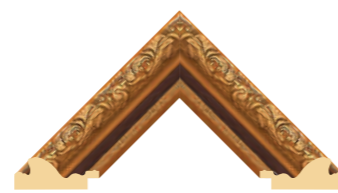

TF-2007-03



TF-2007-T3

TF-2007-03



TF-2007-GS



CLASSIC PICTURE FRAME

CLASSIC STYLE – TF-1021

28 mm (1 1/2 អ៊ុយ)

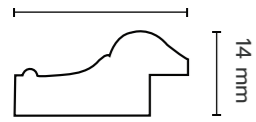

ឧបករណ៍ : 28 មម. X 14 មម.
1 គ្រឿង : 100 មម (ប្រាកដ 3 ម.)



TF-1021-03

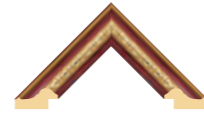

TF-1021-OR



TF-1021-GS



TF-1021-031

CLASSIC STYLE – TF-1143

25 mm (1 1/4 អ៊ុយ)

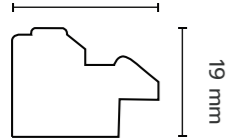

ឧបករណ៍ : 25 មម. X 19 មម.
1 គ្រឿង : 64 មម (ប្រាកដ 3 ម.)

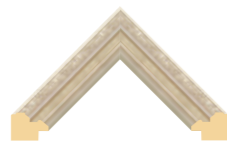

TF-1143-WC



TF-1143-GM

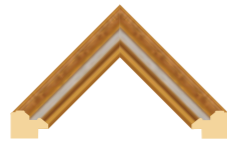

TF-1143-GM1



TF-1143-RS



TF-1021-03



TF-1143-RS



TF-1143-GM1

CLASSIC PICTURE FRAME

CLASSIC STYLE – TF-1022

28 mm (1 ប៉ូ 1 រុយ)

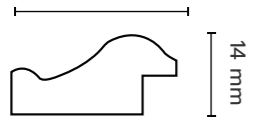

ឃាត : 28 ម. X 14 ម.
1 ក្លែង : 100 គ្រឹម (មក 3 ម.)



TF-1022-GS



TF-1022-O3



TF-1022-OR

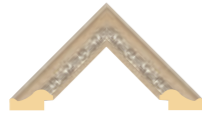

TF-1022-WC



TF-1022-T2



TF-1022-GM1



TF-1022-GM



TF-1022-GS9



TF-1022-GS1



TF-1022-GM1

CLASSIC PICTURE FRAME

CLASSIC STYLE – TF-3101

40 mm (1 1/2 4 កុ)

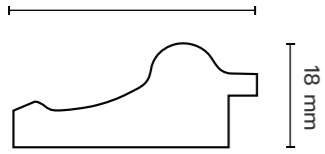

ឧបករណ៍ : 40 មម. X 18 មម.
1 ក្រណាត់ : 60 សេន (មក 3 ម.)



TF-3101-GM

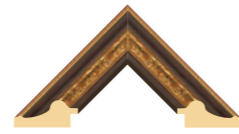

TF-3101-O3



TF-3101-OR



TF-3101-WC



TF-3101-O32



TF-3101-O31



TF-3101-O34



TF-3101-WM



TF-3101-GM1



TF-3101-GM2



TF-3101-O33



TF-3101-GS1



TF-3101-GM



TF-3101-OR

CLASSIC PICTURE FRAME

CLASSIC STYLE – TF-1025

29 mm (1 ប៉ូ 1 អុ)

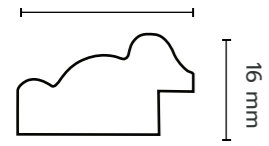

ឧទា : 29 មម. X 16 មម.
1 ក្លែង : 72 ត្រីន (មក 3 ម.)



TF-1025-GM



TF-1025-O2

CLASSIC STYLE – TF-1032

28 mm (1 ប៉ូ 1 អុ)

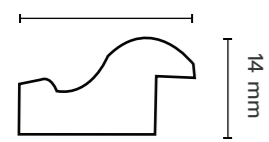

ឧទា : 28 មម. X 14 មម.
1 ក្លែង : 100 ត្រីន (មក 3 ម.)



TF-1032-O3



TF-1032-O2

CLASSIC STYLE – TF-1510

48 mm (1 ប៉ូ 7 អុ)

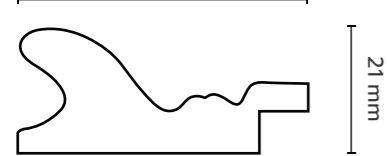

ឧទា : 48 មម. X 21 មម.
1 ក្លែង : 35 ត្រីន (មក 3 ម.)



TF-1510-GS



TF-1510-O3

CLASSIC STYLE – TF-2003

52 mm (2 ប៉ូ)

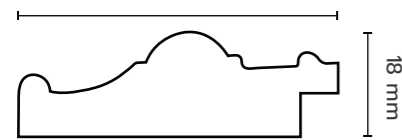

ឧទា : 52 មម. X 18 មម.
1 ក្លែង : 36 ត្រីន (មក 3 ម.)

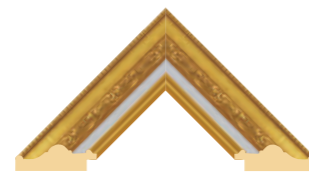

TF-2003-GM2



TF-2003-GM1



TF-2003-GM3



TF-1025-GM

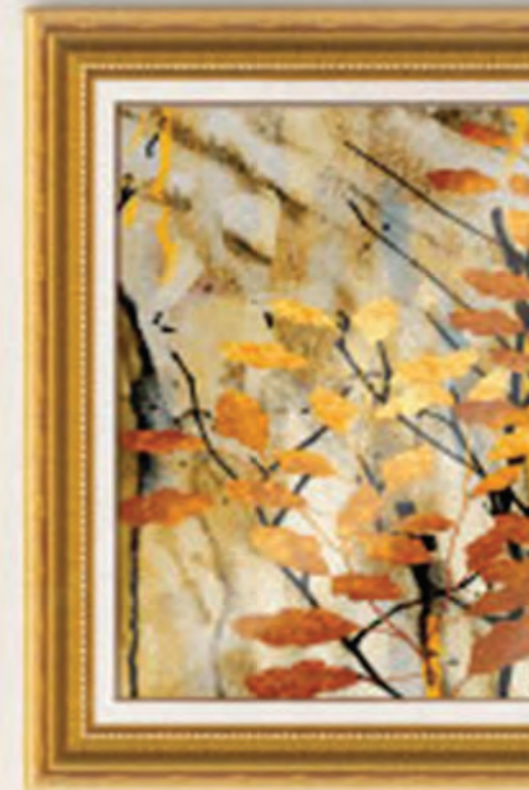

TF-2003-GM2



TF-1510-GS



TF-2003-GM1

CLASSIC PICTURE FRAME

CLASSIC STYLE – TF-3101

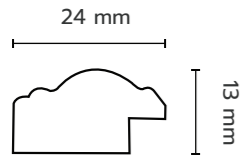

ឧបករណ៍ : 24 មម. X 13 មម.
1 ក្រឡា : 100 ម៉ែត្រ (មាន 3 ម.)

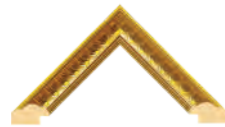

TF-1027-GS



TF-1027-O2



TF-1027-O3



TF-1027-O1

CLASSIC STYLE – TF-2051

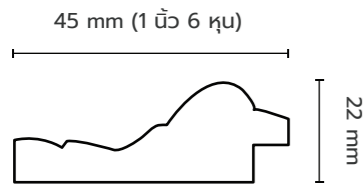

ឧបករណ៍ : 45 មម. X 22 មម.
1 ក្រឡា : 40 ម៉ែត្រ (មាន 3 ម.)



TF-2051-O3

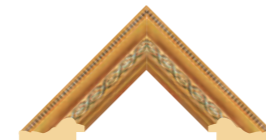

TF-2051-GS

CLASSIC STYLE – TF-0129

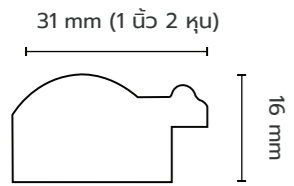

ឧបករណ៍ : 31 មម. X 16 មម.
1 ក្រឡា : 53 ម៉ែត្រ (មាន 3 ម.)



TF-0129-GS



TF-0129-O3



TF-0129-OR

CLASSIC STYLE – TF-1028

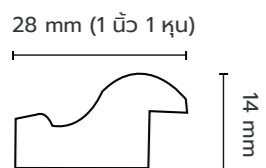

ឧបករណ៍ : 28 មម. X 14 មម.
1 ក្រឡា : 100 ម៉ែត្រ (មាន 3 ម.)



TF-1028-GM



TF-1028-WC

TF-0129-O3



TF-0129-OR



CLASSIC PICTURE FRAME

CLASSIC STYLE – TF-7901

20 mm (6 អ៊ុយ)

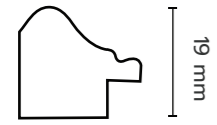

ឧបករណ៍ : 20 មម. X 19 មម.
1 ក្បាល : 90 ទ្រីន (មែក 3 ម.)

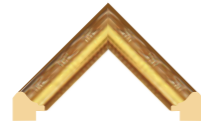

TF-7901-GS

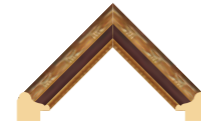

TF-7901-O3

CLASSIC STYLE – TF-1053

25 mm (1 ប៊ូក)

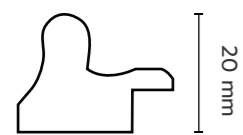

ឧបករណ៍ : 25 មម. X 20 មម.
1 ក្បាល : 69 ទ្រីន (មែក 3 ម.)



TF-1053-GS



TF-1053-O3

CLASSIC STYLE – TF-7906

20 mm

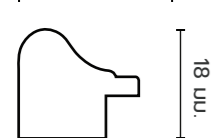

ឧបករណ៍ : 20 មម. X 18 មម.
1 ក្បាល : 90 ទ្រីន (មែក 3 ម.)



TF-7906-GS

CLASSIC STYLE – TF-7909

20 mm

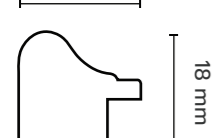

ឧបករណ៍ : 20 មម. X 18 មម.
1 ក្បាល : 90 ទ្រីន (មែក 3 ម.)

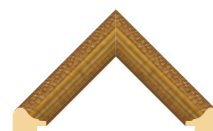

TF-7909-GS

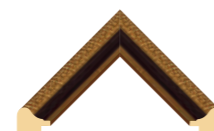

TF-7909-O3

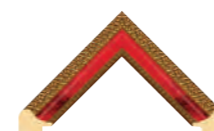

TF-7909-MR



TF-7901-GS



TF-7901-O3



TF-1053-GS



TF-7909-GS

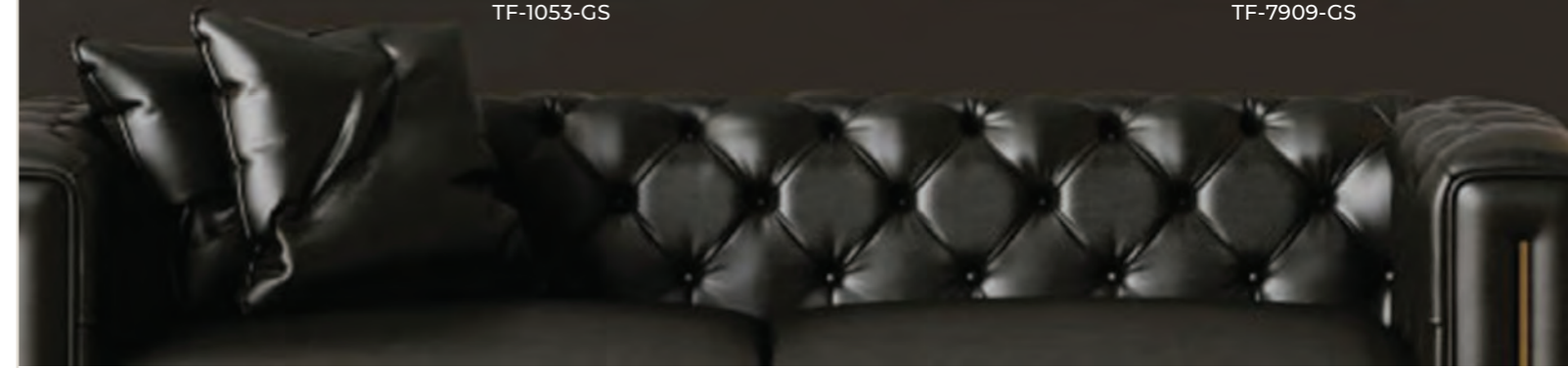

CLASSIC PICTURE FRAME

CLASSIC STYLE – TF-1401

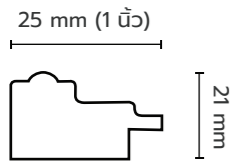

ขนาด : 25 มม. X 21 มม.
1 កង្កែប : 56 គ្រឿង (មាន 3 ម.)



TF-1401-GS

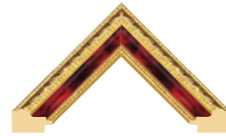

TF-1401-MR



TF-1401-O3

CLASSIC STYLE – TF-1034

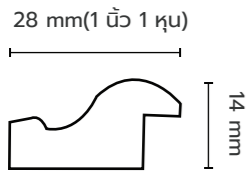

ขนาด : 28 มม. X 14 มม.
1 កង្កែប : 100 គ្រឿង (មាន 3 ម.)



TF-1034-O2

CLASSIC STYLE – TF-1123

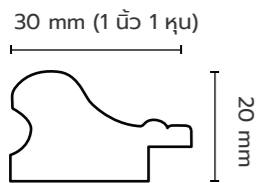

ขนาด : 30 มม. X 20 มม.
1 កង្កែប : 56 គ្រឿង (មាន 3 ម.)

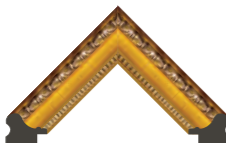

TF-1123-GM

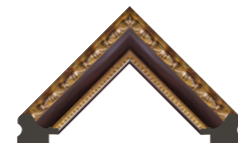

TF-1123-O3

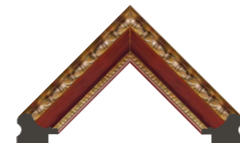

TF-1123-OR



TF-1123-WC



TF-1123-O31



TF-1123-O32

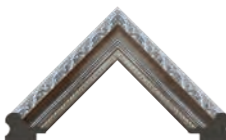

TF-1123-AT

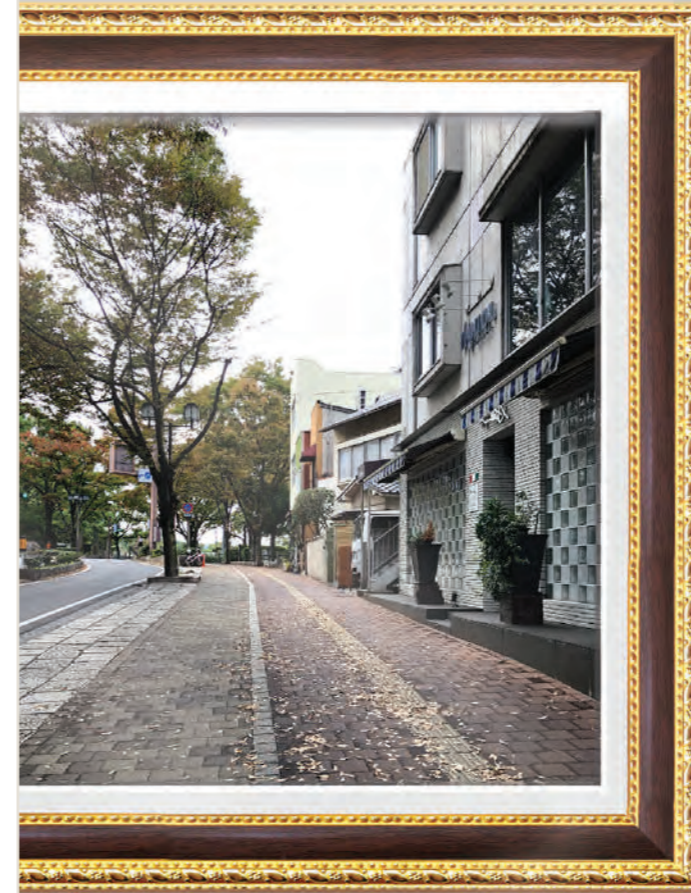

TF-1401-MR



TF-1123-O31



TF-1123-OR

CLASSIC PICTURE FRAME

CLASSIC STYLE – TF-1021

40 mm (1 1/2" 4 អុ)

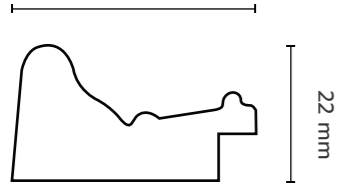

ឧបករណ៍ : 40 មម. X 22 មម.
1 ក្រណាត់ : 38 ត្រីម (មធ្យម 3 ម.)

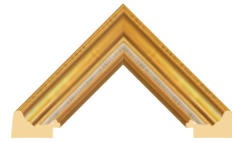

TF-1057-GS

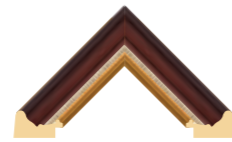

TF-1057-OR



TF-1057-M2



TF-1057-T1

CLASSIC STYLE – TF-3022

39 mm (1 1/2" 4 អុ)

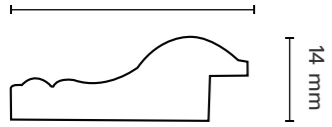

ឧបករណ៍ : 39 មម. X 14 មម.
1 ក្រណាត់ : 72 ត្រីម (មធ្យម 3 ម.)



TF-3022-GS



TF-3022-O3

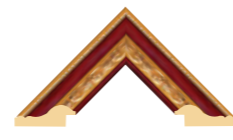

TF-3022-OR

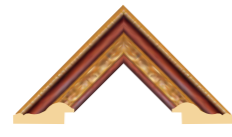

TF-3022-T2



TF-3022-GM

TF-1057-M2



TF-1057-OR

TF-3022-O3



CLASSIC PICTURE FRAME

CLASSIC STYLE – TF-2056

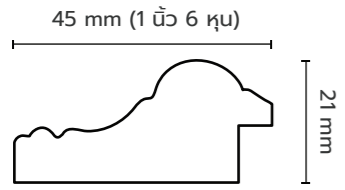

ឧបាទ : 45 មម. X 21 មម.
1 ក្រណាត់ : 40 ត្រីន (មរក 3 ម.)



TF-2056-GS

TF-2056-OR

TF-2056-O3



TF-2056-WC

TF-2056-GA

TF-2056-O31



TF-2056-O32

TF-2056-O33

TF-2056-O34



TF-2056-MR

TF-2056-WM

TF-2056-WC1



TF-2056-GM1

TF-2056-GS1

TF-2056-GS2



TF-2056-GM



TF-2056-GS1



TF-2056-GS2

CLASSIC PICTURE FRAME

CLASSIC STYLE – TF-2006

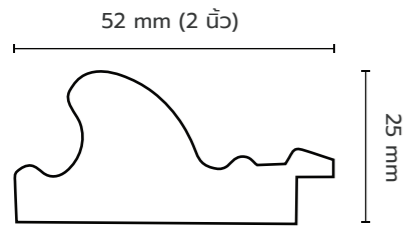

ขนาด : 52 มม. X 25 มม.
1 กล้อง : 24 เส้น (ยาว 3 ม.)

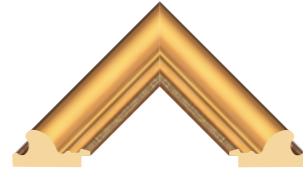

TF-2006-GS

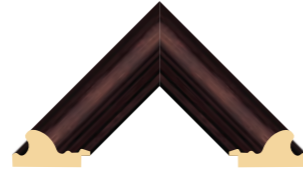

TF-2006-O3

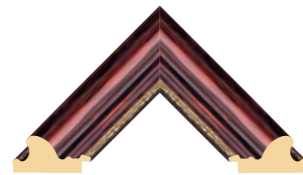

TF-2006-T2

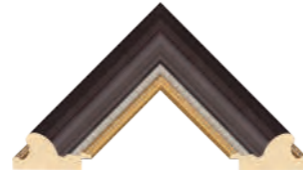

TF-2006-O31



TF-2006-MR



TF-2006-WM



TF-2006-GM



TF-2006-GM1



TF-2006-GM

CLASSIC PICTURE FRAME

CLASSIC STYLE – TF-2262

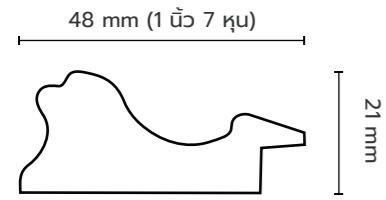

ឧទាហរណ៍ : 48 មម. X 21 មម.
1 ក្រណាត់ : 32 ទំព័រ (ម្យ៉ាង 3 ម.)



TF-2262-GS



TF-2262-O3

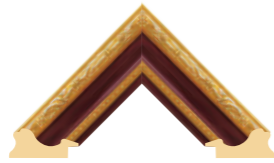

TF-2262-OR



TF-2262-GM

CLASSIC STYLE – TF-2009

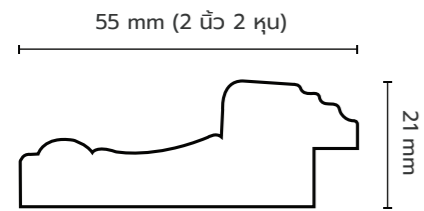

ឧទាហរណ៍ : 55 មម. X 21 មម.
1 ក្រណាត់ : 32 ទំព័រ (ម្យ៉ាង 3 ម.)



TF-2009-O3



TF-2009-WM



TF-2009-WC



TF-2009-GM



TF-2262-GM



TF-2009-GM

CLASSIC PICTURE FRAME

CLASSIC STYLE – TF-3556

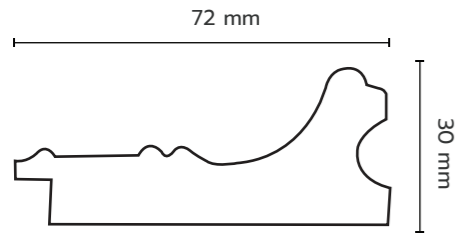

ຂະໜາດ : 72 ມມ. X 30 ມມ.
1 ຄ່ອນ : 18 ເສັ້ນ (ຍາກ 3 ມ.)



TF-3556-GM

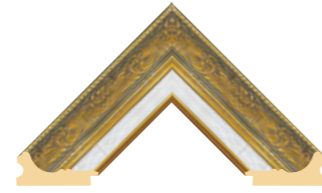

TF-3556-GM1



TF-3556-RA



TF-3556-WC

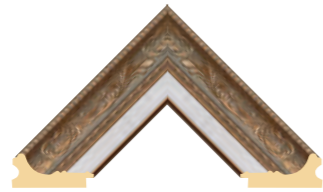

TF-3556-GA



TF-3556-WC

CLASSIC PICTURE FRAME

CLASSIC STYLE – TF-3559

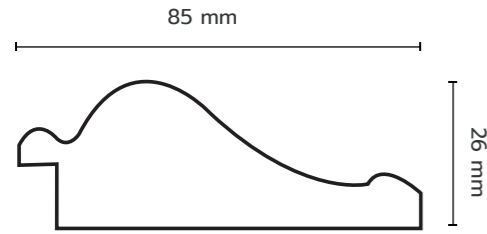

ขนาด : 85 มม. X 26 มม.
1 หลอด : 16 เส้น (ยาว 3 ม.)



TF-3559-GM



TF-3559-RA



TF-3559-GA



TF-3559-WC



TF-3559-SM2

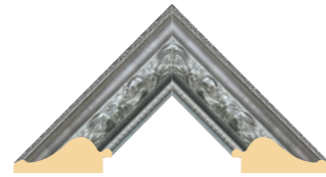

TF-3559-SM1



TF-3559-GA

CLASSIC PICTURE FRAME

CLASSIC STYLE – TF-4403

17 mm (5 អុ)

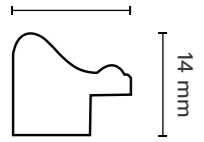

រាង : 17 ម. X 14 ម.
1 គ្រឿង : 144 គ្រឿង (ម. 3 ម.)



TF-4403-GM



TF-4403-O3

CLASSIC STYLE – TF-7703

19 mm (1 ម៉ែ)

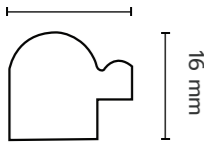

រាង : 19 ម. X 16 ម.
1 គ្រឿង : 91 គ្រឿង (ម. 3 ម.)



TF-7703-GS

CLASSIC STYLE – TF-7710

19 mm (1 ម៉ែ)

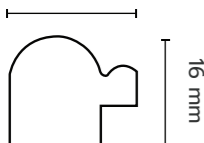

រាង : 19 ម. X 16 ម.
1 គ្រឿង : 91 គ្រឿង (ម. 3 ម.)



TF-7710-GS

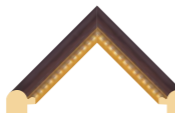

TF-7710-O3

TF-4403-O3



TF-7710-O3



CLASSIC PICTURE FRAME

CLASSIC STYLE – TF-7801

19 mm (6 ¼)

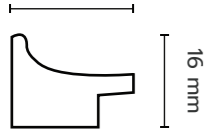

TF-7801-GS

גובה : 19 מ"מ. X 16 מ"מ.
1 חלק : 91 ס"מ (ע"מ 3 מ.)

CLASSIC STYLE – TF-7802

19 mm (6 ¼)

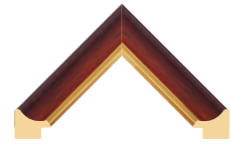
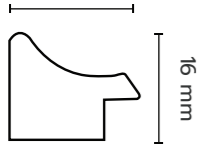

TF-7802-OR

גובה : 19 מ"מ. X 16 מ"מ.
1 חלק : 91 ס"מ (ע"מ 3 מ.)

CLASSIC STYLE – TF-7803

20 mm (6 ¾)

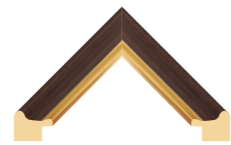
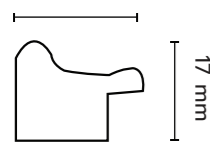

TF-7803-O3

גובה : 20 מ"מ. X 17 מ"מ.
1 חלק : 91 ס"מ (ע"מ 3 מ.)

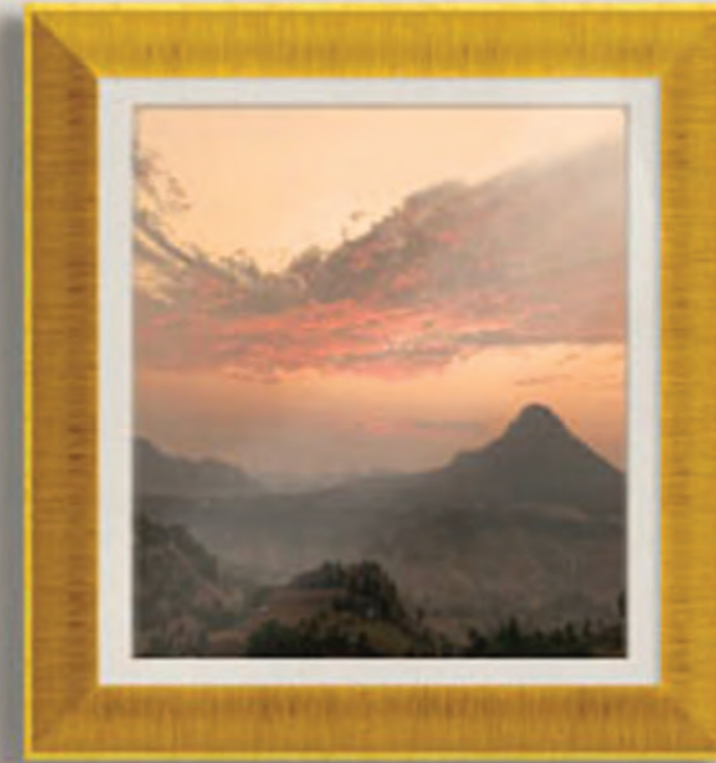

TF-7801-GS



TF-7803-O3



TF-7802-OR



CLASSIC PICTURE FRAME

CLASSIC STYLE – TF-6021

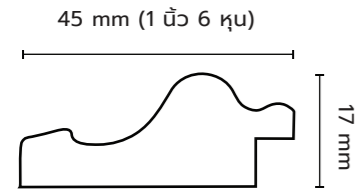

ឆរា : 45 ម. X 17 ម.
1 ក្លែង : 45 ឆែន (មរា 3 ម.)



TF-6021-GM



TF-6021-O3



TF-6021-OR



TF-6021-WC

CLASSIC STYLE – TF-3021

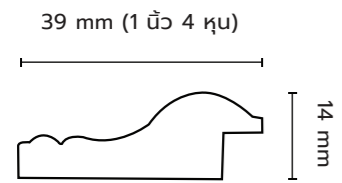

ឆរា : 39 ម. X 14 ម.
1 ក្លែង : 72 ឆែន (មរា 3 ម.)

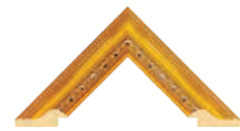

TF-3021-GS



TF-3201-O3



TF-3021-OR

TF-6021-O3



TF-6021-GM



TF-6021-OR



TF-3201-O3



LUXURY PICTURE FRAME

LUXURY STYLE – TF-1124

34 mm (1 1/2" 3 4")

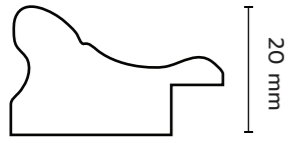

ขนาด : 34 มม. X 20 มม.
1 กล่อง : 52 เส้น (ยาว 3 ม.)



TF-1124-GS



TF-1124-WS



TF-1124-AT



TF-1124-O3



TF-1124-BM



TF-1124-RS



TF-1124-GA

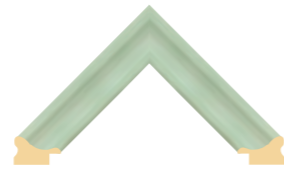

TF-1124-CG

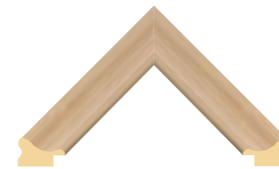

TF-1124-T1



TF-1124-T2

TF-1124-AT



TF-1124-O3

LUXURY PICTURE FRAME

LUXURY STYLE – TF-2005

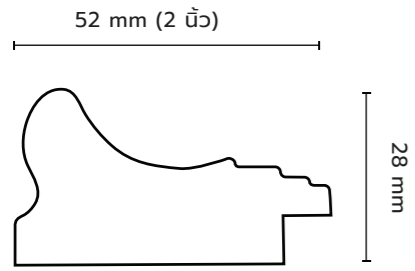

ขนาด : 52 มม. X 28 มม.
1 กล้อง : 24 เส้น (ยาว 3 ม.)



TF-2005-GS



TF-2005-O3



TF-2005-WM



TF-2005-AT



TF-2005-RS

TF-2005-AT



LUXURY PICTURE FRAME

LUXURY STYLE – TF-1153

44 mm (1 1/2 6 អុ)

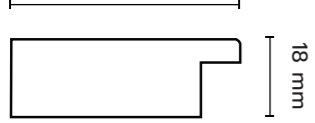

សរុប : 44 ម. X 18 ម.
1 ក្លែង : 35 ឆ្នាំ (មាន 3 ម.)

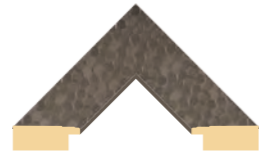

TF-1153-AT

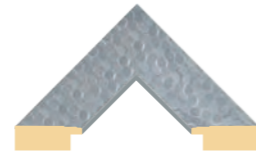

TF-1153-WM

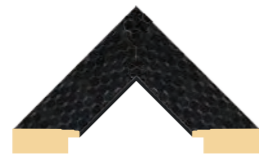

TF-1153-BM

LUXURY STYLE – TF-2001

69 mm (2 3/4 6 អុ)

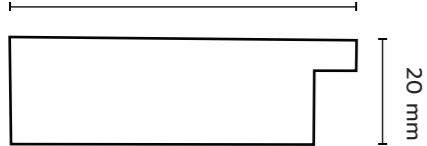

សរុប : 69 ម. X 20 ម.
1 ក្លែង : 18 ឆ្នាំ (មាន 3 ម.)



TF-2001-AT

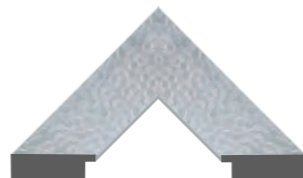

TF-2001-WM



TF-2001-BM

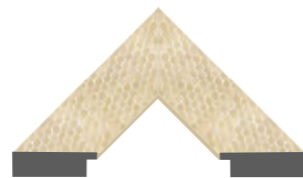

TF-2001-WC



TF-1153-AT



TF-2001-AT



MINIMAL PICTURE FRAME

MINIMAL – TF-4402

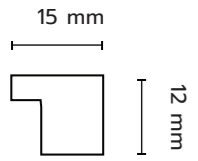

ຂາດ : 15 ມມ. X 12 ມມ.
1 ຄ່ອນ : 144 ເສັ້ນ (ຍາກ 3 ມ.)



TF-4402-GS



TF-4402-O3



TF-4402-OR

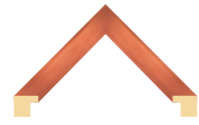

TF-4402-RM



TF-4402-WM



TF-4402-AT



TF-4402-BM

MINIMAL – TF-1011

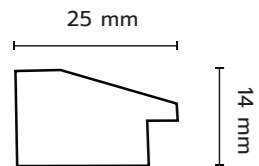

ຂາດ : 25 ມມ. X 14 ມມ.
1 ຄ່ອນ : 72 ເສັ້ນ (ຍາກ 3 ມ.)

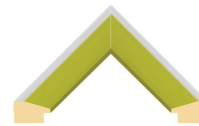

TF-1011-CG



TF-1011-CR



TF-1011-CP



TF-1011-CB

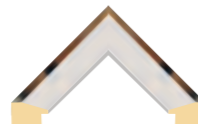

TF-1011-WS

MINIMAL – TF-0401

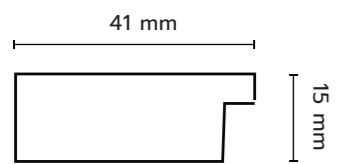

ຂາດ : 41 ມມ. X 15 ມມ.
1 ຄ່ອນ : 32 ເສັ້ນ (ຍາກ 3 ມ.)



TF-0401-BM



TF-4402-BM



MINIMAL PICTURE FRAME

MINIMAL – TF-2000

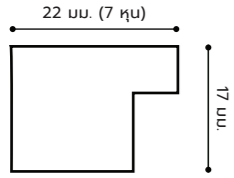

ขนาด : 22 มม. X 17 มม.
1 ក្រឡា : 80 ត្រី (មាន 3 ម.)

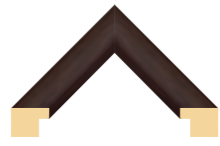

TF-2000-O3



TF-2000-WM



TF-2000-BM



TF-2000-GC



TF-2000-CR



TF-2000-CP

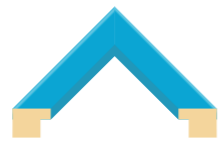

TF-2000-CB



TF-2000-GM



TF-2000-5M



TF-2000-T3



TF-2000-O2



TF-2000-WM

MINIMAL PICTURE FRAME

MINIMAL – TF-1152

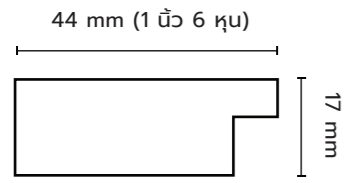

ຂະໜາດ : 44 ມມ. X 17 ມມ.
1 ກ່ອງ : 35 ເລັ່ນ (ຍາກ 3 ມ.)



MINIMAL – TF-1142

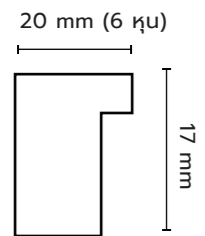

ຂະໜາດ : 20 ມມ. X 27 ມມ.
1 ກ່ອງ : 56 ເລັ່ນ (ຍາກ 3 ມ.)



TF-1152-BM



TF-1142-BM



TF-1142-T2



MINIMAL PICTURE FRAME

MINIMAL – TF-1100

30 mm (1 1/2 นิ้ว)

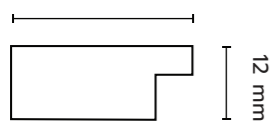

ขนาด : 30 มม. X 12 มม.
1 กล่อง : 80 เส้น (ยาว 3 ม.)



TF-1100-BM



TF-1100-WM

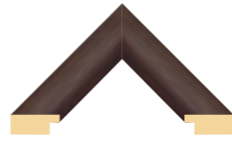

TF-1100-O3

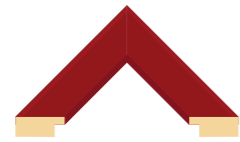

TF-1100-CR



TF-1100-CP



TF-1100-CB



TF-1100-CG

MINIMAL – TF-7806

20 mm (6 มม.)

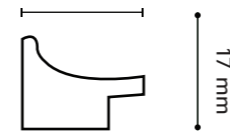

ขนาด : 20 มม. X 17 มม.
1 กล่อง : 91 เส้น (ยาว 3 ม.)



TF-7806-CG



TF-7806-CR



TF-7806-CP



TF-7806-CV



TF-7806-CB



TF-7806-WM



TF-1100-BM



TF-7806-CR



MODERN PICTURE FRAME

MODERN – TF-1121

32 mm (1 1/2 អុ)

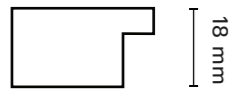

ប្រវែង : 32 មម. X 18 មម.
1 ក្រណាត់ : 50 មម. (មធ្យម 3 ម.)



TF-1121-O3



TF-1121-T2



TF-1121-WM



TF-1121-BM

MODERN – TF-1155

44 mm (1 3/4 អុ)

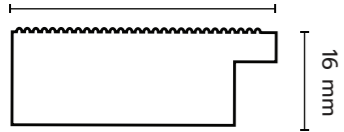

ប្រវែង : 44 មម. X 16 មម.
1 ក្រណាត់ : 40 មម. (មធ្យម 3 ម.)



TF-1155-WC



TF-1155-O2

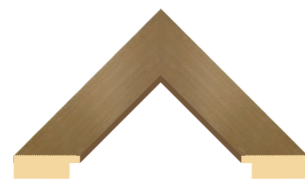

TF-1155-AT

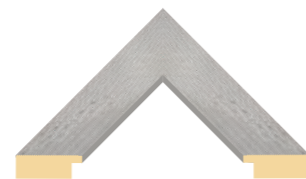

TF-1155-SM

TF-1121-O3



TF-1155-O2



TF-1121-T2

MODERN PICTURE FRAME

MODERN – TF-1141

25 mm (1 นิ้ว)

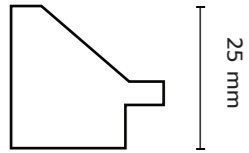

ขนาด : 25 มม. X 25 มม.
1 กล้อง : 48 เส้น (ยาว 3 ม.)

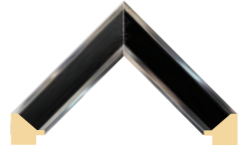

TF-1141-BM

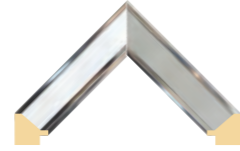

TF-1141-WM

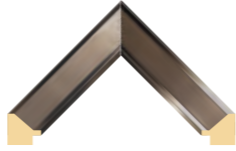

TF-1141-AT



TF-1141-T2

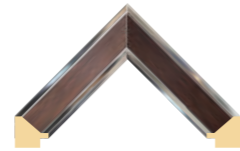

TF-1141-O3

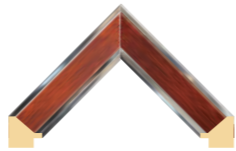

TF-1141-OR



TF-1141-O1

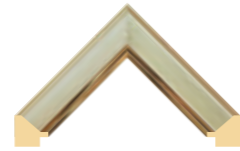

TF-1141-WM1



TF-1141-RM

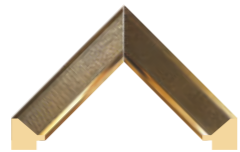

TF-1141-GA

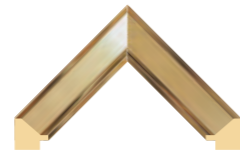

TF-1141-GM



TF-1141-BM1

TF-1141-BM



TF-1141-O3



MODERN PICTURE FRAME

MODERN – TF-2558

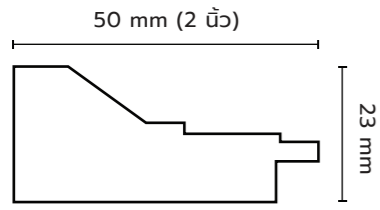

ขนาด : 50 มม. X 23 มม.
1 หล่อง : 28 เส้น (ยาว 3 ม.)

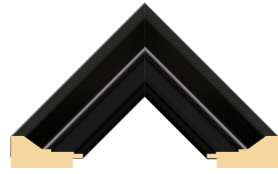

TF-2558-BM

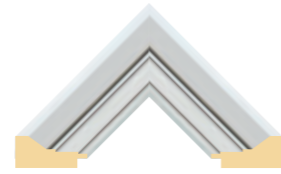

TF-2558-WM

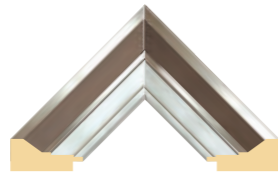

TF-2558-AS

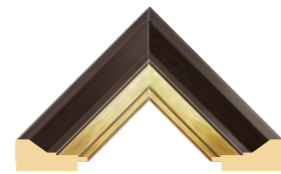

TF-2558-GA

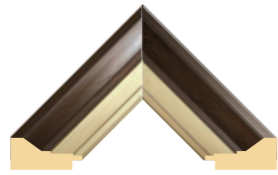

TF-2558-TI

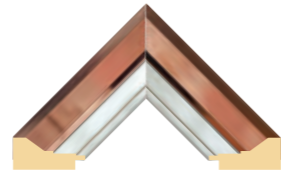

TF-2558-RS

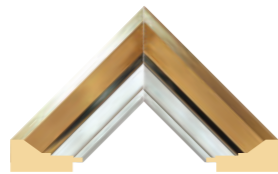

TF-2558-GS

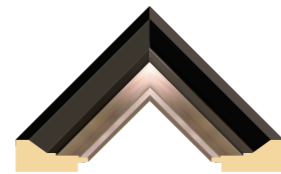

TF-2558-AT

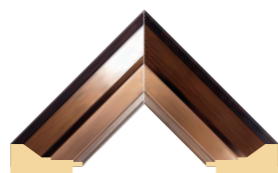

TF-2558-RA



TF-2258-GM

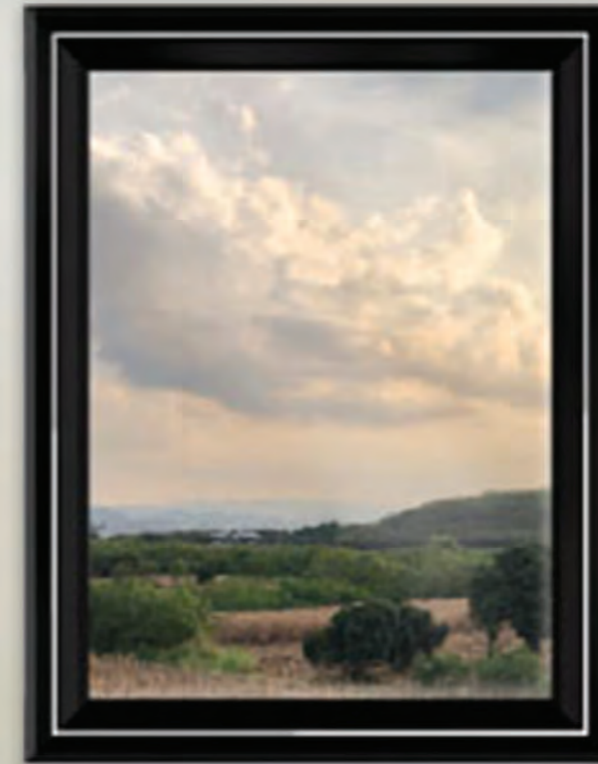

TF-2558-BM

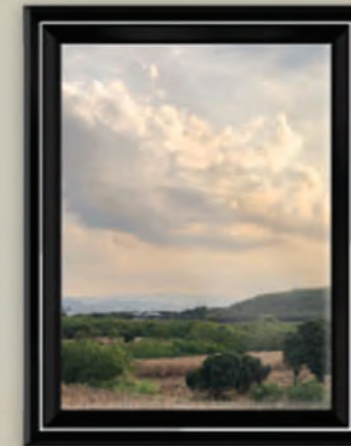

MODERN PICTURE FRAME

MODERN – TF-2002

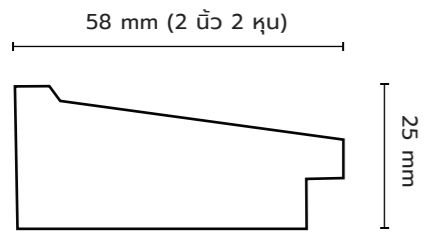

ขนาด : 58 มม. X 25 มม.
1 กล่อง : 22 เส้น (ยาว 3 ม.)



TF-2002-BM

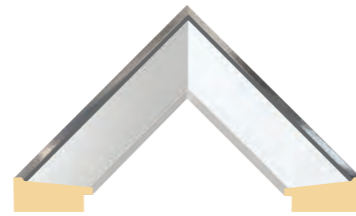

TF-2002-WM



TF-2002-T1

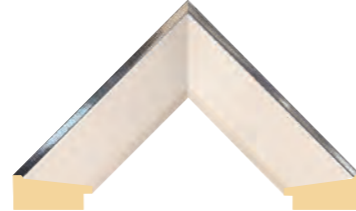

TF-2002-WC



TF-2002-WM1



TF-2002-GA



TF-2002-O3



TF-2002-WM2

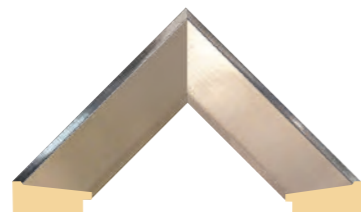

TF-2002-AT



TF-2002-GM

TF-2002-BM



MODERN PICTURE FRAME

MODERN – TF-3558

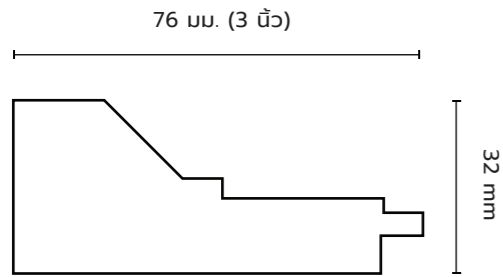

ขนาด : 76 มม. X 32 มม.
1 กล้อง : 12 เส้น (ยาว 3 ม.)

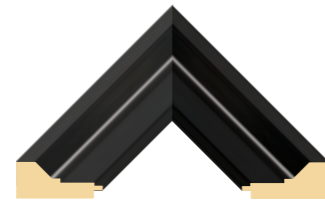

TF-3558-BM

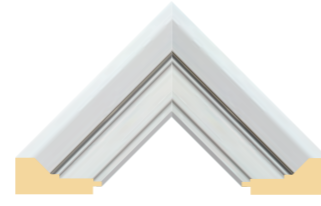

TF-3558-WM

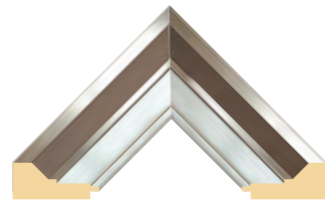

TF-3558-AS

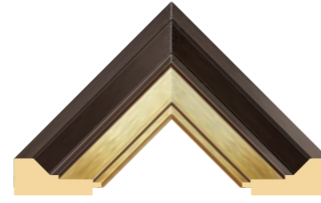

TF-3558-GA

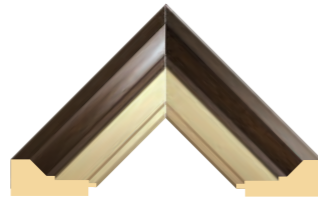

TF-3558-T1

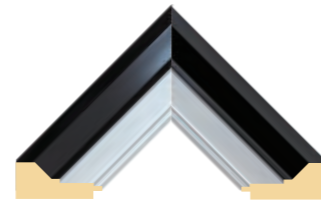

TF-3558-BW

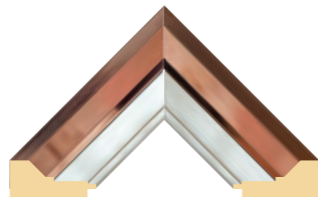

TF-3558-RS

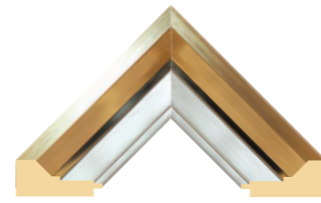

TF-3558-GM

TF-3558-BM

TF-3558-T1



MODERN PICTURE FRAME

MODERN – TF-4021

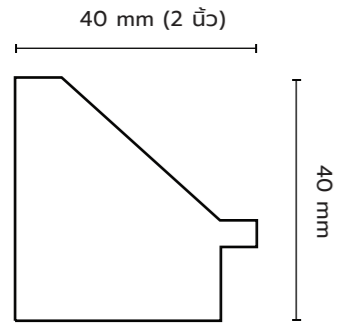

ขนาด : 40 มม. X 40 มม.
1 กล้อง : 20 เส้น (ยาว 3 ม.)

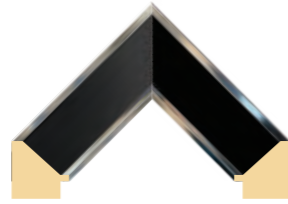

TF-4021-BM

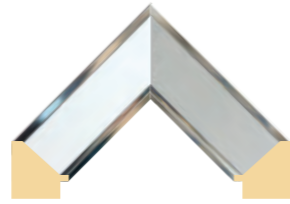

TF-4021-WM

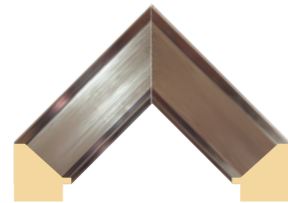

TF-4021-AT

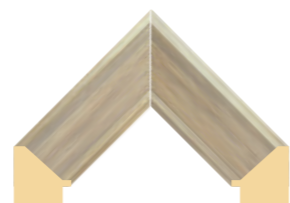

TF-4021-T1



TF-4021-O3



TF-4021-TR

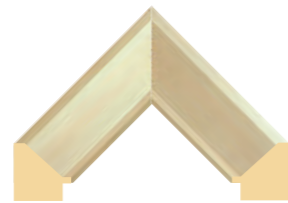

TF-4021-WC

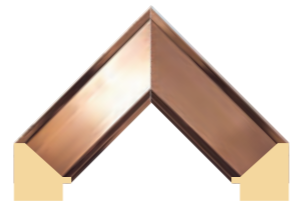

TF-4021-RM

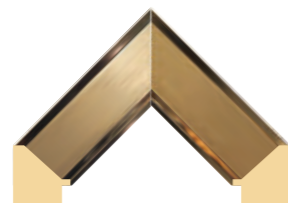

TF-4021-GM

TF-4021-O3



MODERN PICTURE FRAME

MODERN – TF-2215

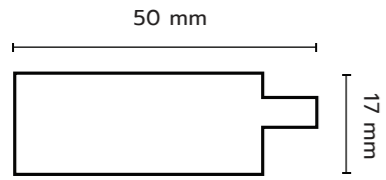

ຂະໜາດ : 50 ມມ. X 17 ມມ.
1 ກ້ວງ : 35 ເສັ້ນ (ຍາກ 3 ມ.)



TF-2215-BM1



TF-2215-WM

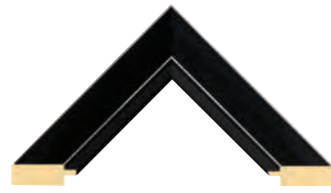

TF-2215-BM



TF-2215-O3

MINIMAL – TF-1157

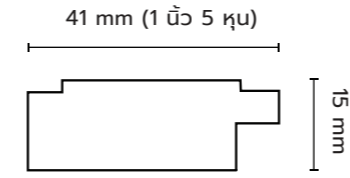

ຂະໜາດ : 41 ມມ. X 15 ມມ.
1 ກ້ວງ : 40 ເສັ້ນ (ຍາກ 3 ມ.)

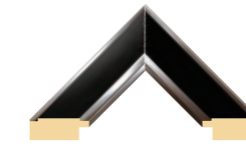

TF-1157-BM

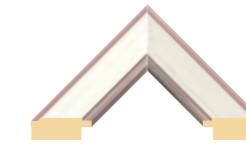

TF-1157-SM

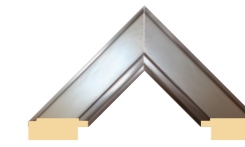

TF-1157-AT

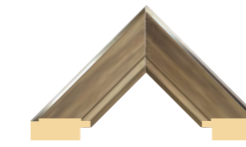

TF-1157-T2



TF-1157-O3



TF-1157-TR



TF-1157-T1

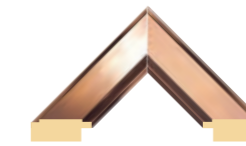

TF-1157-RM

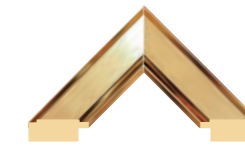

TF-1157-GM

TF-2215-O3



TF-1157-AT



TF-1157-BM



VINTAGE PICTURE FRAME

VINTAGE – TF-1029

29 mm (1 ជ័ក 1 អុម)

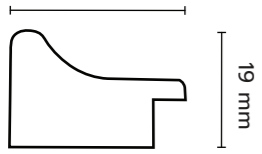

ឧបករណ៍ : 29 មម. X 19 មម.
1 ក្រណាត់ : 56 ទ្រីន (មាន 3 ម.)



TF-1029-O3



TF-1029-T21



TF-1029-BS



TF-1029-WC2



TF-1029-WC1



TF-1029-T22

VINTAGE – TF-3040

31 mm (1 ជ័ក 2 អុម)

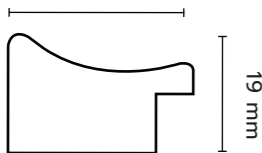

ឧបករណ៍ : 31 មម. X 19 មម.
1 ក្រណាត់ : 50 ទ្រីន (មាន 3 ម.)



TF-3040-T2

VINTAGE – TF-3601

36 mm (1 ជ័ក 3 អុម)

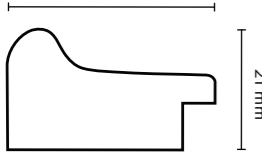

ឧបករណ៍ : 36 មម. X 21 មម.
1 ក្រណាត់ : 48 ទ្រីន (មាន 3 ម.)



TF-3601-OR



TF-3601-M3

TF-1029-BS



TF-1029-O3



TF-3601-OR



TF-3040-T2



VINTAGE PICTURE FRAME

VINTAGE – TF-2059

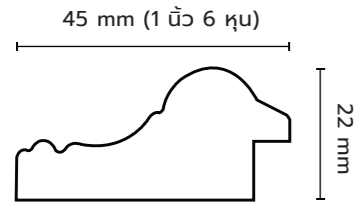

ຂາດ : 45 ມມ. X 22 ມມ.
1 ຄລ່ອ : 40 ເສັ້ນ (ຍາວ 3 ມ.)



TF-2059-GM



TF-2059-O3



TF-2059-T1



TF-2059-MR

VINTAGE – TF-2552

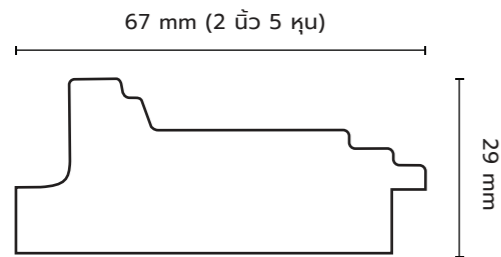

ຂາດ : 67 ມມ. X 29 ມມ.
1 ຄລ່ອ : 18 ເສັ້ນ (ຍາວ 3 ມ.)



TF-2552-GM



TF-2552-O3



TF-2552-WC



TF-2552-BM



TF-2059-O3



TF-2552-O3



TF-2552-BM



VINTAGE PICTURE FRAME

VINTAGE – TF-2214

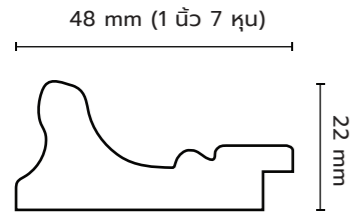

ຂາດ : 48 ມມ. X 22 ມມ.
1 ຄລ່ອຈ : 32 ເສັ້ນ (ຍາກ 3 ມ.)



TF-2214-GM



TF-2214-T3



TF-2214-WC



TF-2214-O3

VINTAGE – TF-2555

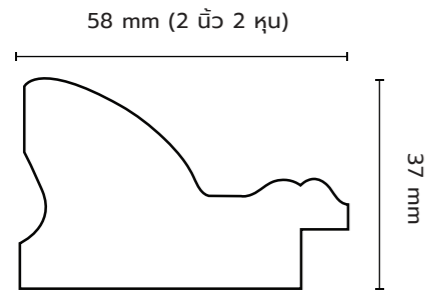

ຂາດ : 58 ມມ. X 37 ມມ.
1 ຄລ່ອຈ : 16 ເສັ້ນ (ຍາກ 3 ມ.)



TF-2555-GS



TF-2555-SM



TF-2555-GA



TF-2555-OR

TF-2555-GS

TF-2555-OR



TF-2214-GM



TF-2214-T3



VINTAGE PICTURE FRAME

VINTAGE – TF-3001

67 mm (2 ជ័ក 5 អុយ)

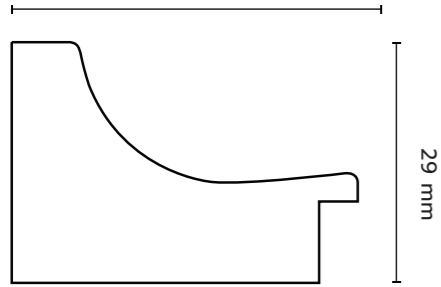

ឧទាហរណ៍ : 67 មម. X 29 មម.
1 ក្រណាត់ : 12 ត្រង់ (មធ្យម 3 ម.)

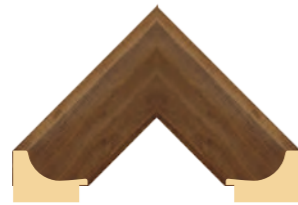

TF-3001-T2



TF-3001-GA2



TF-3001-GA1



TF-3001-O3



TF-3001-GD



TF-3001-WC

VINTAGE – TF-2008

60 mm (2 ជ័ក 3 អុយ)

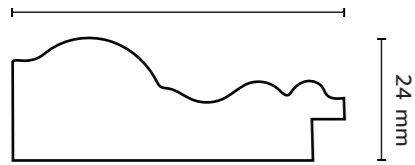

ឧទាហរណ៍ : 60 មម. X 24 មម.
1 ក្រណាត់ : 22 ត្រង់ (មធ្យម 3 ម.)

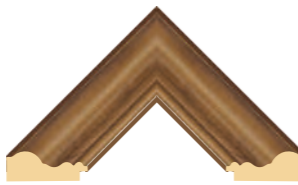

TF-2008-O1



TF-2008-SW



TF-2008-SC



TF-2008-SN



TF-2008-SB

TF-3001-GA1

TF-2008-O1



TF-2008-SN



04 Picture Frame

កន្លែងបង្ហាញ

CLASSIC PICTURE FRAME

CLASSIC STYLE —TF-0119

35 mm (1 ប៉ូ 3 អុ)

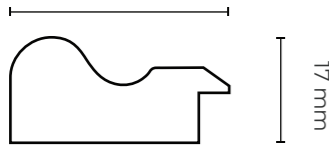

17 mm

ឧទា : 35 ម. X 17 ម.
1 កង្វះ : 54 ទ្រីន (មក 3 ម.)



TF-0119-GS

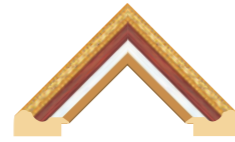

TF-0119-CR



TF-0119-02

CLASSIC STYLE —TF-0249

33 mm (1 ប៉ូ 2 អុ)

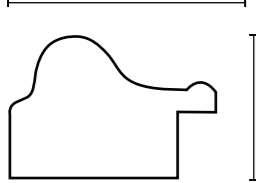

23 mm

ឧទា : 33 ម. X 23 ម.
1 កង្វះ : 42 ទ្រីន (មក 3 ម.)

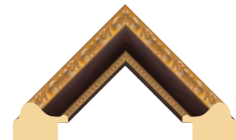

TF-0249-03



TF-0249-GS



TF-0249-CR

CLASSIC STYLE —TF-1031

28 mm

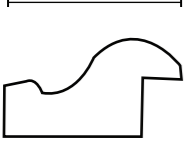

14 mm

ឧទា : 28 ម. X 14 ម.
1 កង្វះ : 100 ទ្រីន (មក 3 ម.)



TF-1031-WC



TF-1031-GM



TF-1031-OR



TF-1031-03



CLASSIC PICTURE FRAME

CLASSIC STYLE —TF-0145

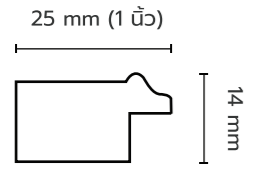

ขนาด : 25 มม. X 14 มม.
1 กล้อง : 81 เส้น (ยาว 3 ม.)



TF-0145-WM



TF-0145-CR



TF-0145-WC



TF-0145-03

CLASSIC STYLE —TF-2021

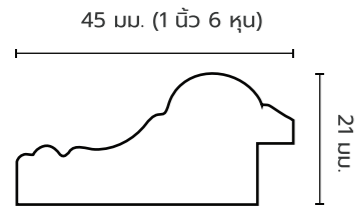

ขนาด : 33 มม. X 23 มม.
1 กล้อง : 42 เส้น (ยาว 3 ม.)

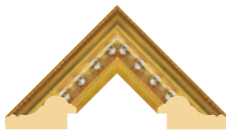

TF-2021-GS



TF-2022-M3

CLASSIC STYLE —TF-2237

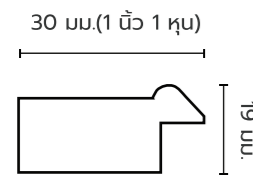

ขนาด : 30 มม. X 19 มม.
1 กล้อง : 72 เส้น (ยาว 3 ม.)



TF-2237-WM



TF-2021-GS

TF-2022-M3



CLASSIC PICTURE FRAME

CLASSIC STYLE —TF-3267

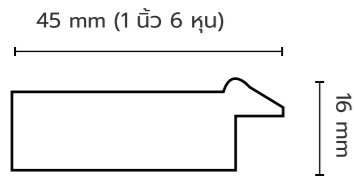

ឆរា : 45 មម. X 21 មម.
1 ក្រដាស : 40 ស៊ែន (មក 3 ម.)

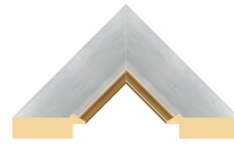

TF-3267-WM

CLASSIC STYLE —TF-0200

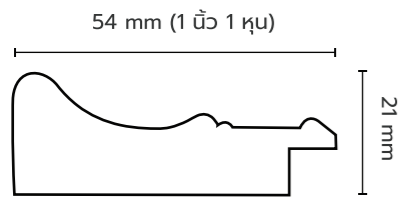

ឆរា : 25 មម. X 14 មម.
1 ក្រដាស : 81 ស៊ែន (មក 3 ម.)

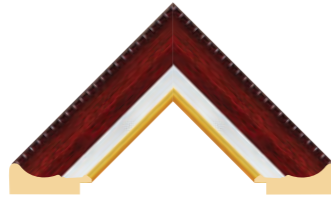

TF-0200-OR



TF-0200-GS



TF-0200-GS1

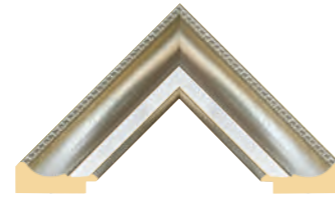

TF-0200-SS

CLASSIC STYLE —TF-2007

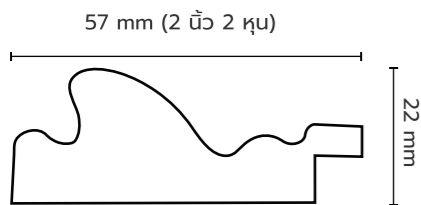

ឆរា : 57 មម. X 22 មម.
1 ក្រដាស : 28 ស៊ែន (មក 3 ម.)

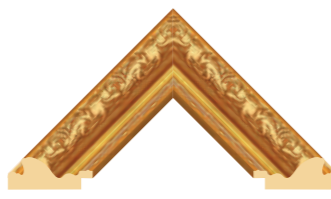

TF-2007-GS

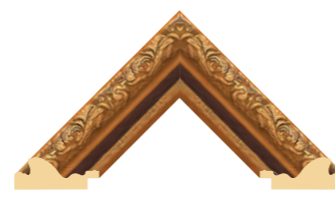

TF-2007-03



TF-2007-T3

TF-2007-03



TF-2007-GS



CLASSIC PICTURE FRAME

CLASSIC STYLE —TF-1021

28 mm (1 1/2 អ៊ុយ)

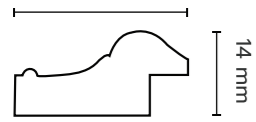

ឧបករណ៍ : 28 មម. X 14 មម.
1 គ្រឿង : 100 ម៉ែត្រ (មាន 3 ម.)



TF-1021-03

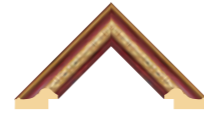

TF-1021-OR



TF-1021-GS



TF-1021-031

CLASSIC STYLE —TF-1143

25 mm (1 1/4 អ៊ុយ)

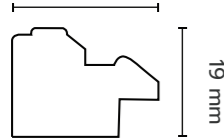

ឧបករណ៍ : 25 មម. X 19 មម.
1 គ្រឿង : 64 ម៉ែត្រ (មាន 3 ម.)

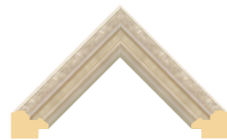

TF-1143-WC



TF-1143-GM

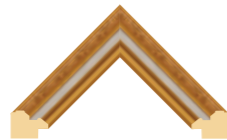

TF-1143-GM1



TF-1143-RS



TF-1021-03

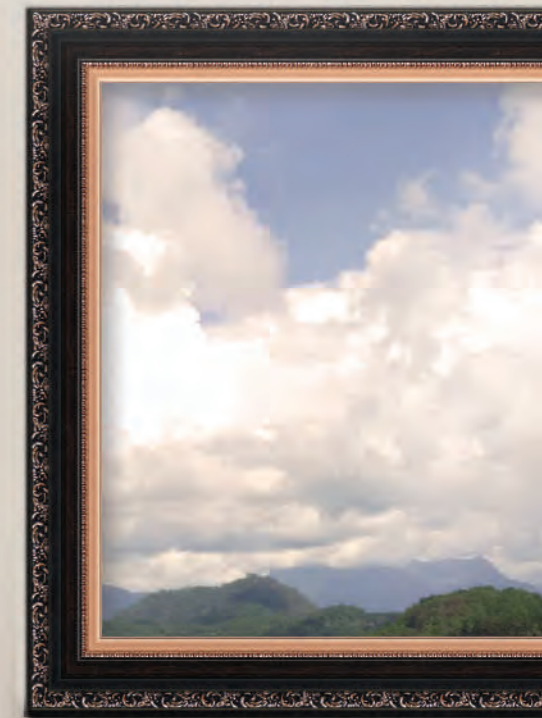

TF-1143-RS



TF-1143-GM1

CLASSIC PICTURE FRAME

CLASSIC STYLE —TF-1022

28 mm (1 ប៉ូ 1 អុ)

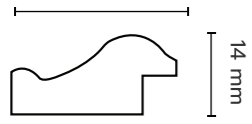

ឧបករណ៍ : 28 មម. X 14 មម.
1 ក្រប : 100 មម. (មធ្យម 3 ម.)



TF-1022-GS



TF-1022-O3



TF-1022-OR



TF-1022-WC



TF-1022-T2



TF-1022-GM1



TF-1022-GM



TF-1022-GS9



TF-1022-GS1



TF-1022-GM1

CLASSIC PICTURE FRAME

CLASSIC STYLE —TF-3101

40 mm (1 1/2 4 កុ)

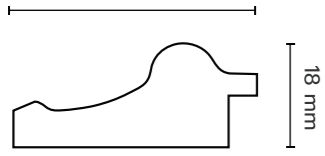

ឧបករណ៍ : 40 មម. X 18 មម.
1 កម្រិត : 60 ស៊េន (ម្យា 3 ម.)



TF-3101-GM



TF-3101-O3



TF-3101-OR



TF-3101-WC



TF-3101-O32



TF-3101-O31



TF-3101-O34



TF-3101-WM



TF-3101-GM1



TF-3101-GM2



TF-3101-O33



TF-3101-GS1



TF-3101-GM



TF-3101-OR

CLASSIC PICTURE FRAME

CLASSIC STYLE —TF-1025

29 mm (1 ប៉ូ 1 អុ)

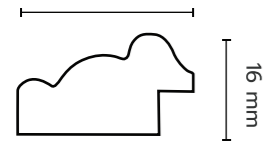

ឧទា : 29 មម. X 16 មម.
1 ក្លែង : 72 ត្រីន (មក 3 ម.)



TF-1025-GM



TF-1025-O2

CLASSIC STYLE —TF-1032

28 mm (1 ប៉ូ 1 អុ)

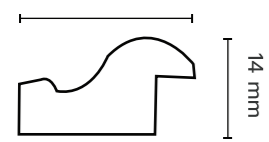

ឧទា : 28 មម. X 14 មម.
1 ក្លែង : 100 ត្រីន (មក 3 ម.)



TF-1032-O3



TF-1032-O2

CLASSIC STYLE —TF-1510

48 mm (1 ប៉ូ 7 អុ)

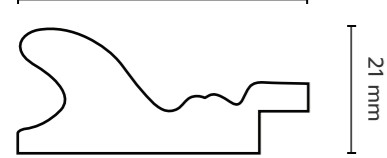

ឧទា : 48 មម. X 21 មម.
1 ក្លែង : 35 ត្រីន (មក 3 ម.)

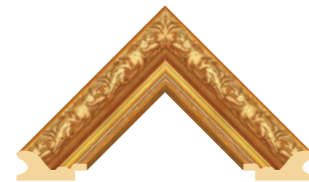

TF-1510-GS



TF-1510-O3

CLASSIC STYLE —TF-2003

52 mm (2 ប៉ូ)

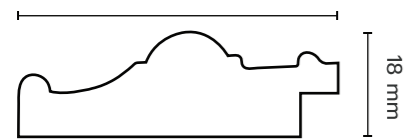

ឧទា : 52 មម. X 18 មម.
1 ក្លែង : 36 ត្រីន (មក 3 ម.)

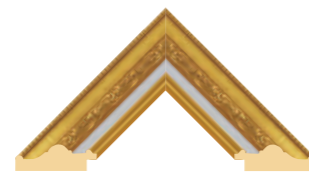

TF-2003-GM2



TF-2003-GM1



TF-2003-GM3



TF-1025-GM

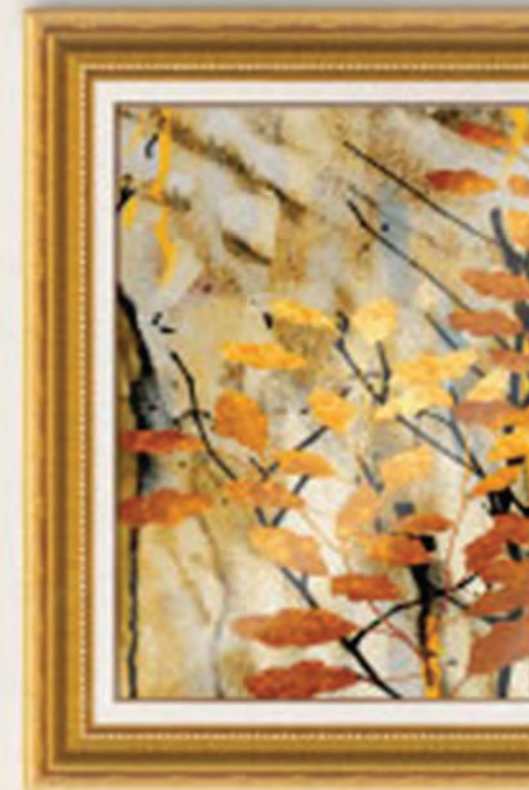

TF-2003-GM2



TF-1510-GS



CLASSIC PICTURE FRAME

CLASSIC STYLE —TF-3101

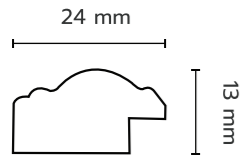

ឧបករណ៍ : 24 មម. X 13 មម.
1 ក្រឡា : 100 ម៉ែត្រ (មាន 3 ម.)

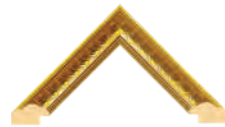

TF-1027-GS



TF-1027-O2



TF-1027-O3



TF-1027-O1

CLASSIC STYLE —TF-2051

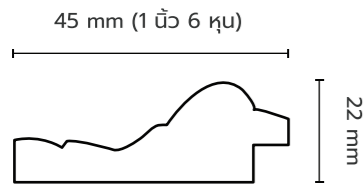

ឧបករណ៍ : 45 មម. X 22 មម.
1 ក្រឡា : 40 ម៉ែត្រ (មាន 3 ម.)



TF-2051-O3

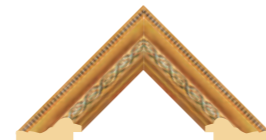

TF-2051-GS

CLASSIC STYLE —TF-0129

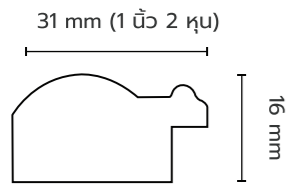

ឧបករណ៍ : 31 មម. X 16 មម.
1 ក្រឡា : 53 ម៉ែត្រ (មាន 3 ម.)



TF-0129-GS



TF-0129-O3



TF-0129-OR

CLASSIC STYLE —TF-1028

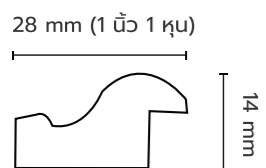

ឧបករណ៍ : 28 មម. X 14 មម.
1 ក្រឡា : 100 ម៉ែត្រ (មាន 3 ម.)



TF-1028-GM



TF-1028-WC

TF-0129-O3



TF-0129-OR

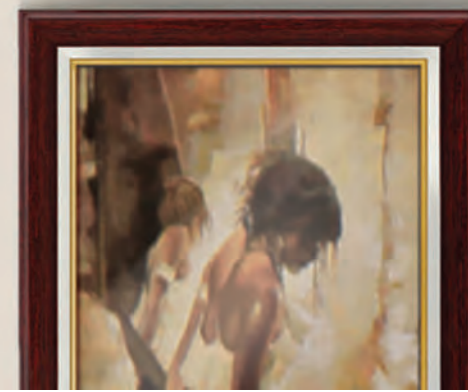

CLASSIC PICTURE FRAME

CLASSIC STYLE —TF-7901

20 mm (6 អ៊ុយ)

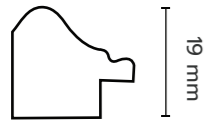

ឧបករណ៍ : 20 មម. X 19 មម.
1 ក្បាល : 90 លើន (ម្យា 3 ម.)

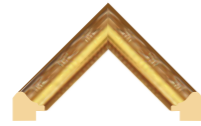

TF-7901-GS



TF-7901-O3

CLASSIC STYLE —TF-1053

25 mm (1 ប៊ូក)

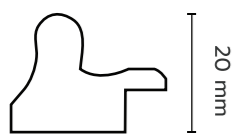

ឧបករណ៍ : 25 មម. X 20 មម.
1 ក្បាល : 69 លើន (ម្យា 3 ម.)



TF-1053-GS



TF-1053-O3

CLASSIC STYLE —TF-7906

20 mm

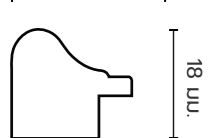

ឧបករណ៍ : 20 មម. X 18 មម.
1 ក្បាល : 90 លើន (ម្យា 3 ម.)



TF-7906-GS

CLASSIC STYLE —TF-7909

20 mm

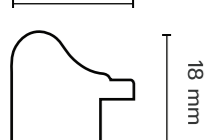

ឧបករណ៍ : 20 មម. X 18 មម.
1 ក្បាល : 90 លើន (ម្យា 3 ម.)

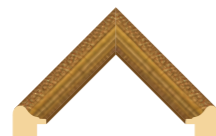

TF-7909-GS

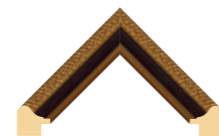

TF-7909-O3



TF-7909-MR



TF-7901-GS



TF-7901-O3



TF-1053-GS



TF-7909-GS

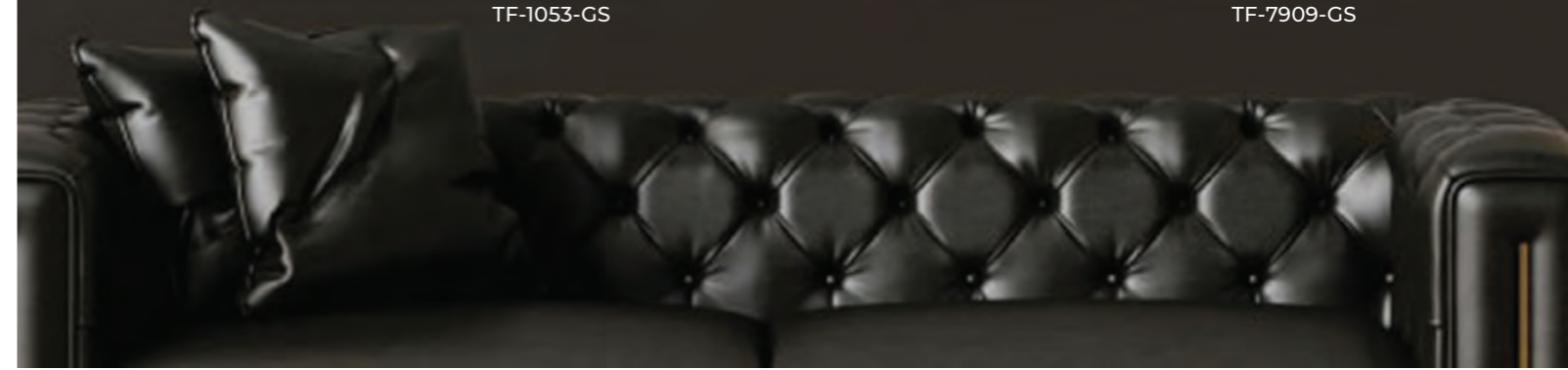

CLASSIC PICTURE FRAME

CLASSIC STYLE —TF-1401

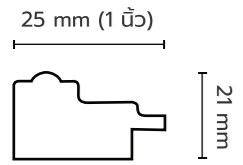

ຂາດ : 25 ມມ. X 21 ມມ.
1 ກ້ອງ : 56 ເສັ້ນ (ຍາກ 3 ມ.)



TF-1401-GS

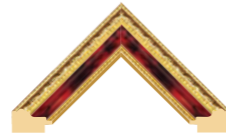

TF-1401-MR



TF-1401-O3

CLASSIC STYLE —TF-1034

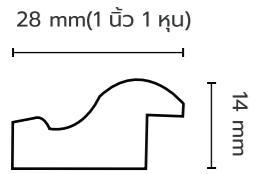

ຂາດ : 28 ມມ. X 14 ມມ.
1 ກ້ອງ : 100 ເສັ້ນ (ຍາກ 3 ມ.)



TF-1034-O2

CLASSIC STYLE —TF-1123

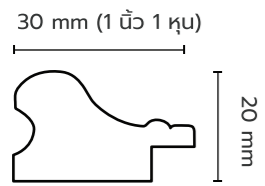

ຂາດ : 30 ມມ. X 20 ມມ.
1 ກ້ອງ : 56 ເສັ້ນ (ຍາກ 3 ມ.)

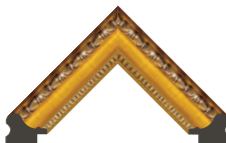

TF-1123-GM



TF-1123-O3

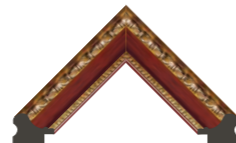

TF-1123-OR



TF-1123-WC



TF-1123-O31



TF-1123-O32

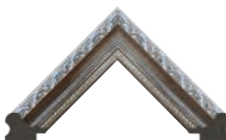

TF-1123-AT

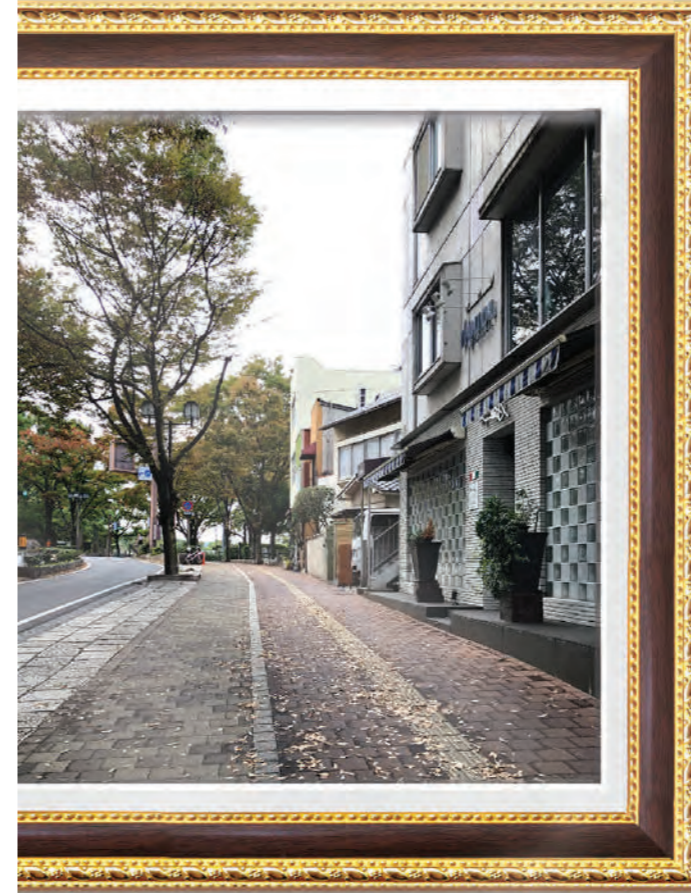

TF-1401-MR



TF-1123-O31



TF-1123-OR

CLASSIC PICTURE FRAME

CLASSIC STYLE —TF-1021

40 mm (1 1/2" 4 អុ)

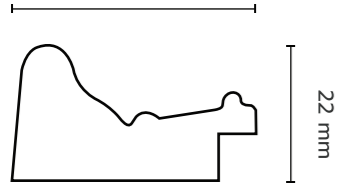

ឧបករណ៍ : 40 មម. X 22 មម.
1 ក្រដាស : 38 ត្រង់ (មធ្យម 3 ម.)



TF-1057-GS

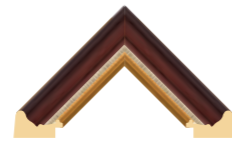

TF-1057-OR



TF-1057-M2



TF-1057-T1

CLASSIC STYLE —TF-3022

39 mm (1 1/2" 4 អុ)

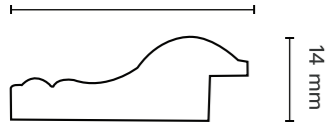

ឧបករណ៍ : 39 មម. X 14 មម.
1 ក្រដាស : 72 ត្រង់ (មធ្យម 3 ម.)



TF-3022-GS



TF-3022-O3

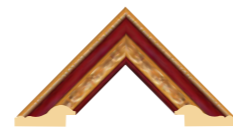

TF-3022-OR

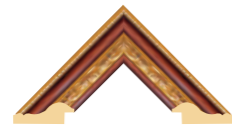

TF-3022-T2



TF-3022-GM

TF-1057-M2

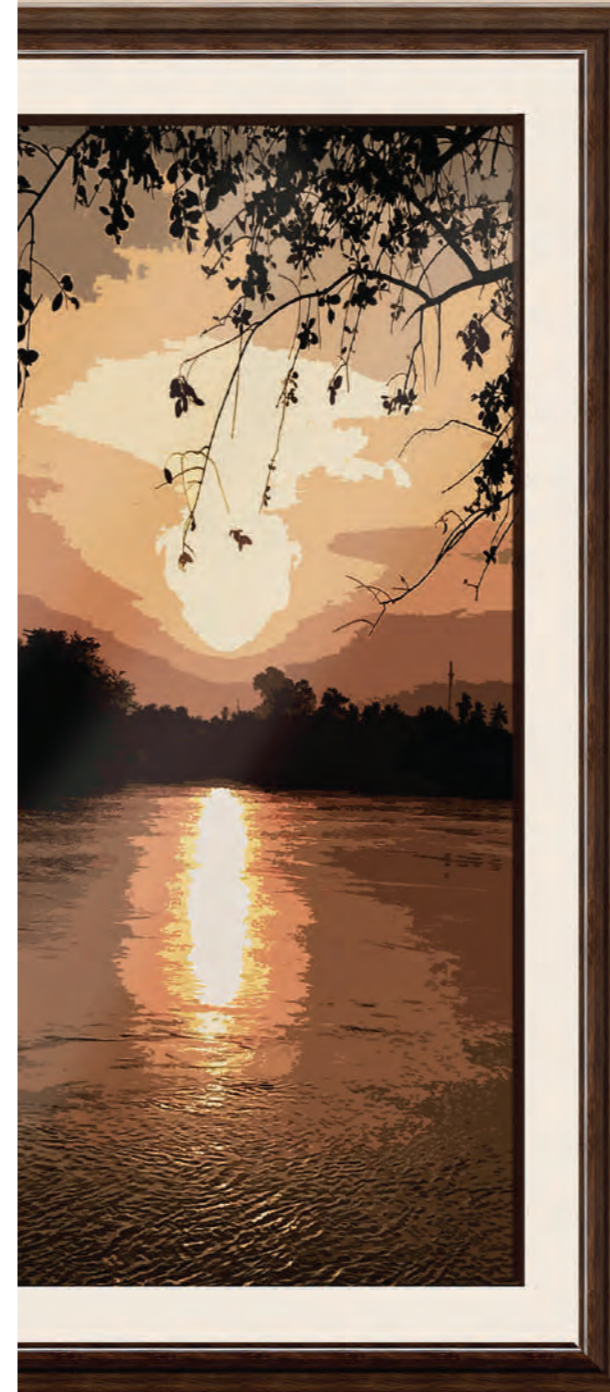

TF-1057-OR

TF-3022-O3



CLASSIC PICTURE FRAME

CLASSIC STYLE —TF-2056

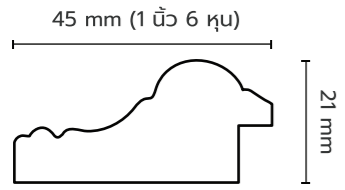

ឧបាទ : 45 មម. X 21 មម.
1 ក្រណាត់ : 40 ត្រីន (មរក 3 ម.)



TF-2056-GS

TF-2056-OR

TF-2056-O3



TF-2056-WC

TF-2056-GA

TF-2056-O31



TF-2056-O32

TF-2056-O33

TF-2056-O34



TF-2056-MR

TF-2056-WM

TF-2056-WC1



TF-2056-GM1

TF-2056-GS1

TF-2056-GS2



TF-2056-GM



TF-2056-GS1



TF-2056-GS2

CLASSIC PICTURE FRAME

CLASSIC STYLE —TF-2006

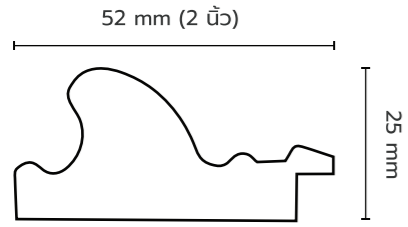

ขนาด : 52 มม. X 25 มม.
1 กล้อง : 24 เส้น (ยาว 3 ม.)

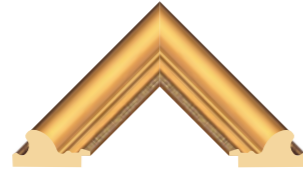

TF-2006-GS

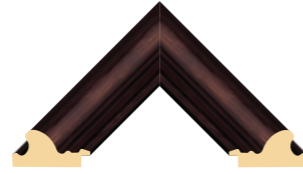

TF-2006-O3

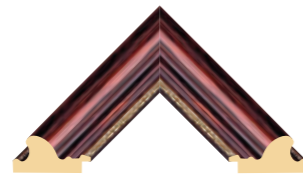

TF-2006-T2



TF-2006-O31



TF-2006-MR



TF-2006-WM



TF-2006-GM



TF-2006-GM1



TF-2006-GM

CLASSIC PICTURE FRAME

CLASSIC STYLE —TF-2262

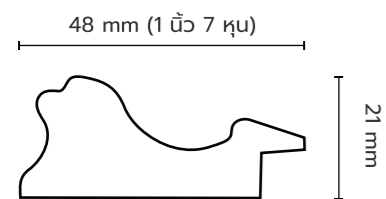

ឆ្នាប : 48 មម. X 21 មម.
1 ក្រណាត់ : 32 ស៊ែន (មែត្រ 3 ម.)



TF-2262-GS



TF-2262-O3

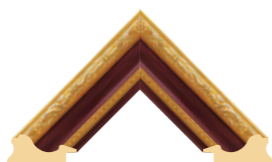

TF-2262-OR



TF-2262-GM

CLASSIC STYLE —TF-2009

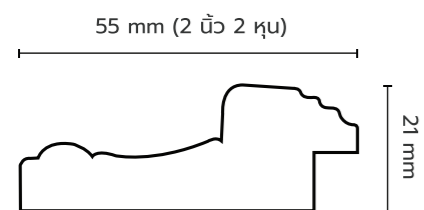

ឆ្នាប : 55 មម. X 21 មម.
1 ក្រណាត់ : 32 ស៊ែន (មែត្រ 3 ម.)



TF-2009-O3



TF-2009-WM



TF-2009-WC



TF-2009-GM



TF-2262-GM

TF-2009-GM

CLASSIC PICTURE FRAME

CLASSIC STYLE —TF-3556

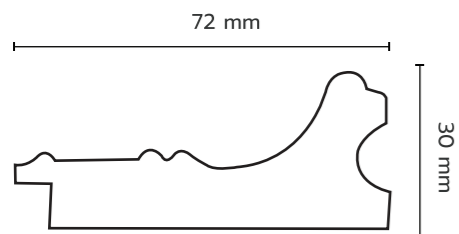

ຂະໜາດ : 72 ມມ. X 30 ມມ.
1 ຄ່ອນ : 18 ເສັ້ນ (ຍາກ 3 ມ.)



TF-3556-GM

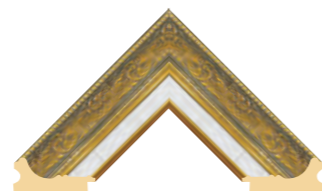

TF-3556-GM1



TF-3556-RA



TF-3556-WC



TF-3556-GA



TF-3556-WC

CLASSIC PICTURE FRAME

CLASSIC STYLE —TF-3559

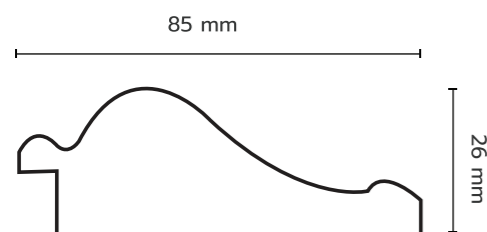

ขนาด : 85 มม. X 26 มม.
1 หลัอง : 16 เส้น (ยก 3 ม.)



TF-3559-GM



TF-3559-RA



TF-3559-GA



TF-3559-WC



TF-3559-SM2

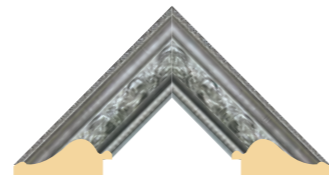

TF-3559-SM1



TF-3559-GA

CLASSIC PICTURE FRAME

CLASSIC STYLE —TF-4403

17 mm (5 អុ)

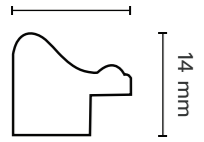

ទទឹង : 17 ម. X 14 ម.
1 គ្រឿង : 144 គ្រឿង (ម. 3 ម.)



TF-4403-GM



TF-4403-O3

CLASSIC STYLE —TF-7703

19 mm (1 ប៉ូ)

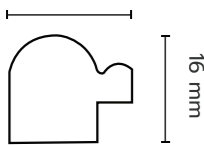

ទទឹង : 19 ម. X 16 ម.
1 គ្រឿង : 91 គ្រឿង (ម. 3 ម.)



TF-7703-GS

CLASSIC STYLE —TF-7710

19 mm (1 ប៉ូ)

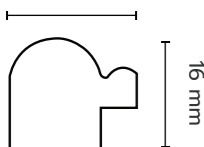

ទទឹង : 19 ម. X 16 ម.
1 គ្រឿង : 91 គ្រឿង (ម. 3 ម.)



TF-7710-GS

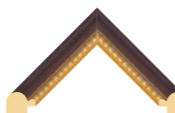

TF-7710-O3

TF-4403-O3



TF-7710-O3



CLASSIC PICTURE FRAME

CLASSIC STYLE —TF-7801

19 mm (6 ફુ)

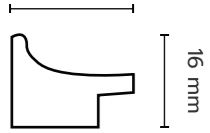

TF-7801-GS

ઠાણ : 19 મમ. X 16 મમ.
1 કલોર : 91 લેન (ઘરા 3 મ.)

CLASSIC STYLE —TF-7802

19 mm (6 ફુ)

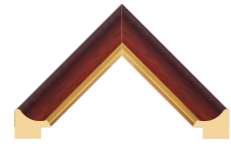
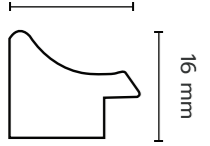

TF-7802-OR

ઠાણ : 19 મમ. X 16 મમ.
1 કલોર : 91 લેન (ઘરા 3 મ.)

CLASSIC STYLE —TF-7803

20 mm (6 ફુ)

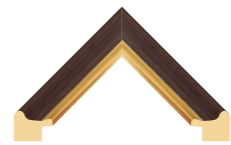
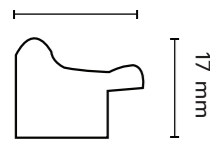

TF-7803-O3

ઠાણ : 20 મમ. X 17 મમ.
1 કલોર : 91 લેન (ઘરા 3 મ.)

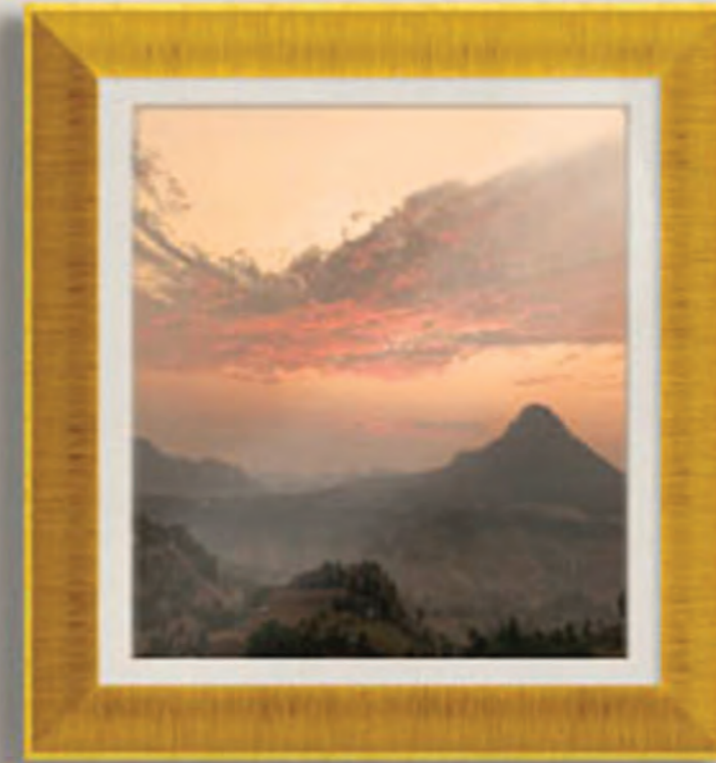

TF-7801-GS



TF-7803-O3



TF-7802-OR



CLASSIC PICTURE FRAME

CLASSIC STYLE —TF-6021

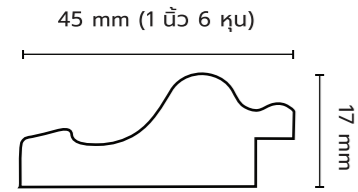

ឧទា : 45 មម. X 17 មម.
1 ក្រណាត់ : 45 ទ្រីន (មរា 3 ម.)



TF-6021-GM



TF-6021-O3

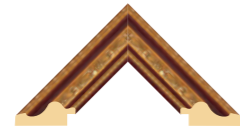

TF-6021-OR



TF-6021-WC

CLASSIC STYLE —TF-3021

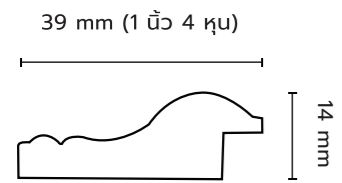

ឧទា : 39 មម. X 14 មម.
1 ក្រណាត់ : 72 ទ្រីន (មរា 3 ម.)



TF-3021-GS



TF-3201-O3



TF-3021-OR

TF-6021-O3



TF-6021-GM



TF-6021-OR

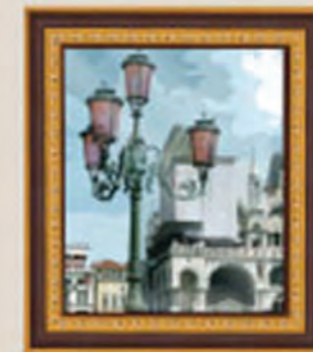

TF-3201-O3



LUXURY PICTURE FRAME

LUXURY STYLE —TF-1124

34 mm (1 1/2" 3 4")

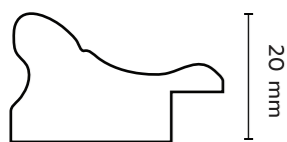

ໜາດ : 34 ມມ. X 20 ມມ.
1 ຄ່ອນ : 52 ເສັ້ນ (ຍາວ 3 ມ.)



TF-1124-GS



TF-1124-WS

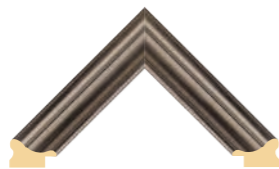

TF-1124-AT



TF-1124-O3



TF-1124-BM



TF-1124-RS



TF-1124-GA



TF-1124-CG

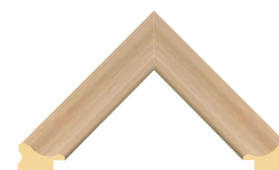

TF-1124-T1



TF-1124-T2

TF-1124-AT



TF-1124-O3

LUXURY PICTURE FRAME

LUXURY STYLE —TF-2005

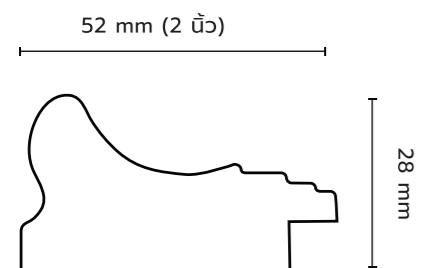

ขนาด : 52 มม. X 28 มม.
1 กล้อง : 24 เส้น (ยาว 3 ม.)



TF-2005-GS



TF-2005-O3



TF-2005-WM



TF-2005-AT



TF-2005-RS

TF-2005-AT



LUXURY PICTURE FRAME

LUXURY STYLE —TF-1153

44 mm (1 1/2 นิ้ว 6 4/8)

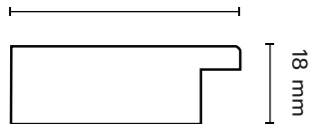

ขนาด : 44 มม. X 18 มม.
1 กล่อง : 35 เส้น (ยาว 3 ม.)

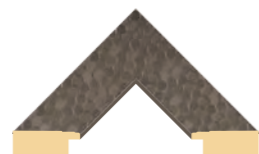

TF-1153-AT

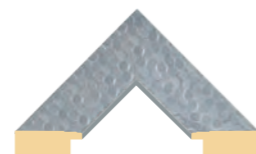

TF-1153-WM



TF-1153-BM

LUXURY STYLE —TF-2001

69 mm (2 3/4 นิ้ว 6 4/8)

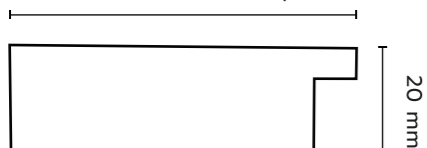

ขนาด : 69 มม. X 20 มม.
1 กล่อง : 18 เส้น (ยาว 3 ม.)



TF-2001-AT



TF-2001-WM



TF-2001-BM

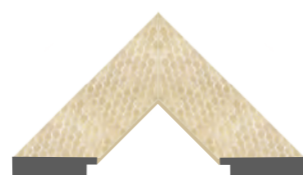

TF-2001-WC



TF-1153-AT



TF-2001-AT



MINIMAL PICTURE FRAME

MINIMAL → TF-4402

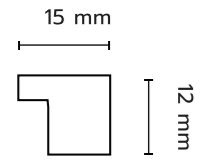

ឧទាហរណ៍ : 15 ម. X 12 ម.
1 ក្រណាត់ : 144 ដេន (ម. 3 ម.)



TF-4402-GS



TF-4402-O3



TF-4402-OR

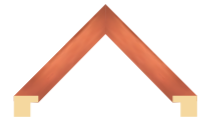

TF-4402-RM



TF-4402-WM



TF-4402-AT



TF-4402-BM

MINIMAL → TF-1011

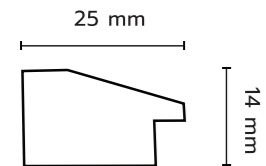

ឧទាហរណ៍ : 25 ម. X 14 ម.
1 ក្រណាត់ : 72 ដេន (ម. 3 ម.)

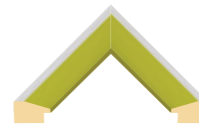

TF-1011-CG



TF-1011-CR



TF-1011-CP



TF-1011-CB

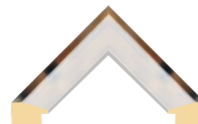

TF-1011-WS

MINIMAL → TF-0401

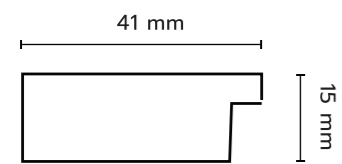

ឧទាហរណ៍ : 41 ម. X 15 ម.
1 ក្រណាត់ : 32 ដេន (ម. 3 ម.)



TF-0401-BM



TF-4402-BM



MINIMAL PICTURE FRAME

MINIMAL —TF-2000

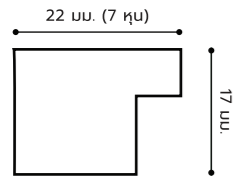

ขนาด : 22 มม. X 17 มม.
1 กล่อง : 80 เส้น (ยาว 3 ม.)

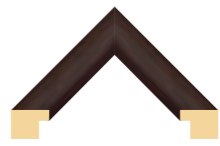

TF-2000-O3



TF-2000-WM



TF-2000-BM



TF-2000-GC



TF-2000-CR



TF-2000-CP

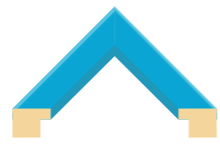

TF-2000-CB



TF-2000-GM



TF-2000-5M



TF-2000-T3



TF-2000-O2



TF-2000-WM

MINIMAL PICTURE FRAME

MINIMAL → TF-1152

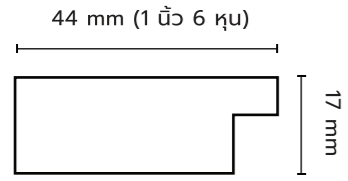

ຂະໜາດ : 44 ມມ. X 17 ມມ.
1 ກ້ວຍ : 35 ເລັ່ນ (ຍາກ 3 ມ.)



MINIMAL → TF-1142

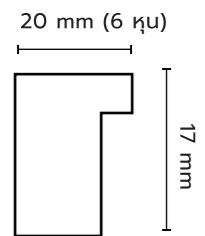

ຂະໜາດ : 20 ມມ. X 27 ມມ.
1 ກ້ວຍ : 56 ເລັ່ນ (ຍາກ 3 ມ.)



TF-1152-BM



TF-1142-BM



TF-1142-T2



MINIMAL PICTURE FRAME

MINIMAL —TF-1100

30 mm (1 1/2 นิ้ว)

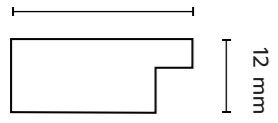

ขนาด : 30 มม. X 12 มม.
1 หลัอง : 80 เส้น (ยาว 3 ม.)

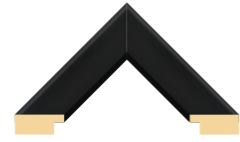

TF-1100-BM



TF-1100-WM

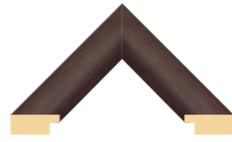

TF-1100-O3

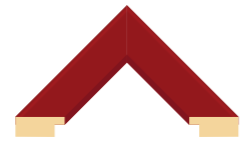

TF-1100-CR



TF-1100-CP



TF-1100-CB



TF-1100-CG

MINIMAL —TF-7806

20 mm (6 มม.)

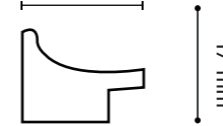

ขนาด : 20 มม. X 17 มม.
1 หลัอง : 91 เส้น (ยาว 3 ม.)



TF-7806-CG



TF-7806-CR



TF-7806-CP



TF-7806-CV



TF-7806-CB



TF-7806-WM



TF-1100-BM



TF-7806-CR

MODERN PICTURE FRAME

MODERN —TF-1121

32 mm (1 1/2" 2 អុ)

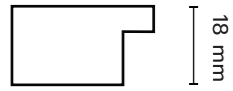

ឧបករណ៍ : 32 មម. X 18 មម.
1 ក្រណាត់ : 50 ទំព័រ (ម្រាម 3 ម.)



TF-1121-O3



TF-1121-T2



TF-1121-WM



TF-1121-BM

MODERN —TF-1155

44 mm (1 3/4" 6 អុ)

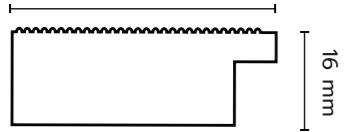

ឧបករណ៍ : 44 មម. X 16 មម.
1 ក្រណាត់ : 40 ទំព័រ (ម្រាម 3 ម.)



TF-1155-WC



TF-1155-O2

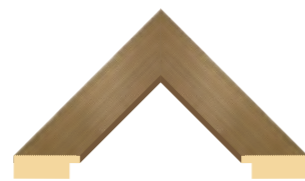

TF-1155-AT



TF-1155-SM

TF-1121-O3



TF-1155-O2



TF-1121-T2

MODERN PICTURE FRAME

MODERN TF-1141

25 mm (1 นิ้ว)

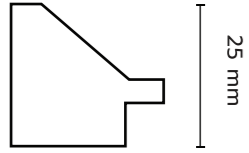

ขนาด : 25 มม. X 25 มม.
1 หลัอง : 48 เส้น (ยาว 3 ม.)

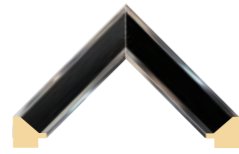

TF-1141-BM

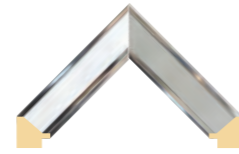

TF-1141-WM

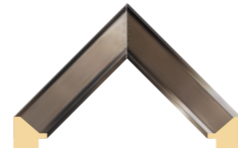

TF-1141-AT



TF-1141-T2

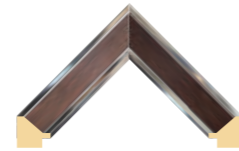

TF-1141-O3

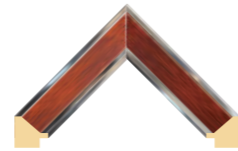

TF-1141-OR

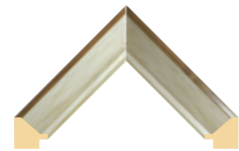

TF-1141-O1

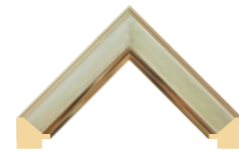

TF-1141-WM1

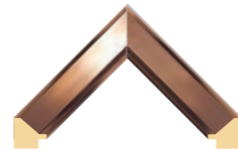

TF-1141-RM



TF-1141-GA

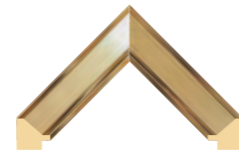

TF-1141-GM



TF-1141-BM1

TF-1141-BM



TF-1141-O3



MODERN PICTURE FRAME

MODERN TF-2558

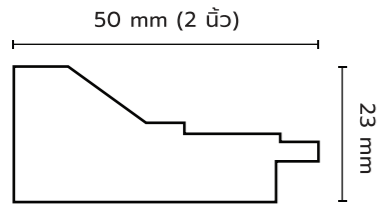

ขนาด : 50 มม. X 23 มม.
1 หล่อง : 28 เส้น (ยาว 3 ม.)

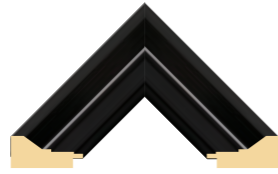

TF-2558-BM

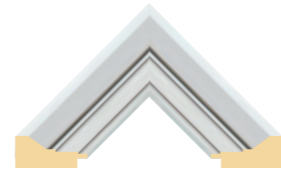

TF-2558-WM

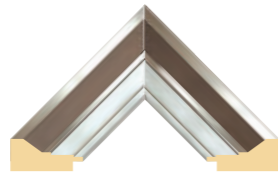

TF-2558-AS

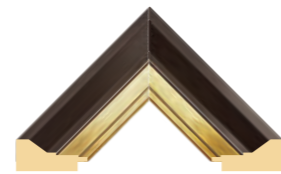

TF-2558-GA

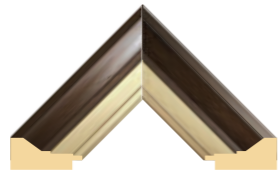

TF-2558-TI

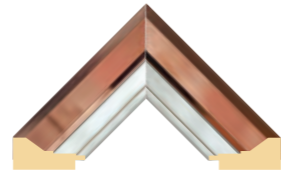

TF-2558-RS

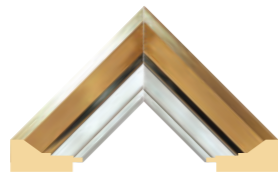

TF-2558-GS

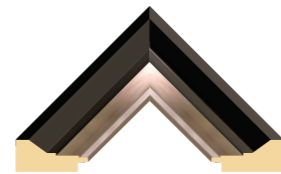

TF-2558-AT

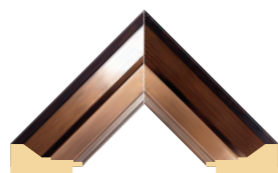

TF-2558-RA



TF-2258-GM

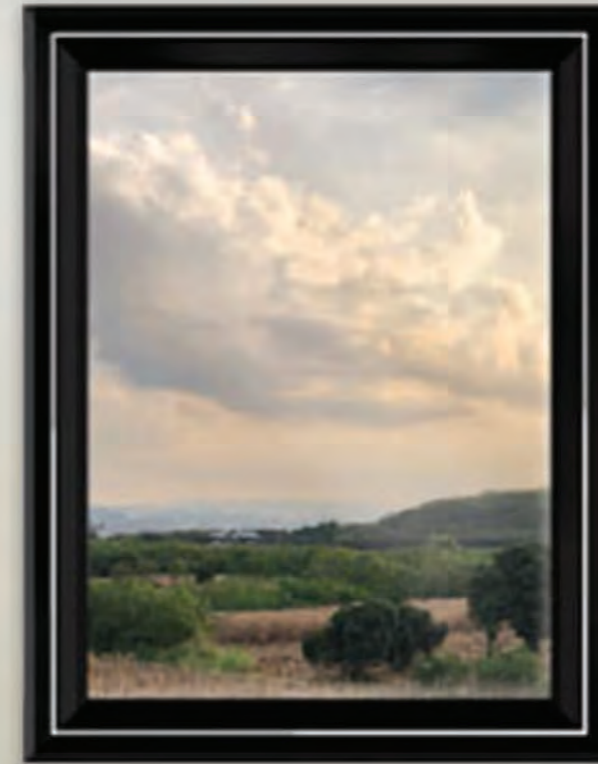

TF-2558-BM

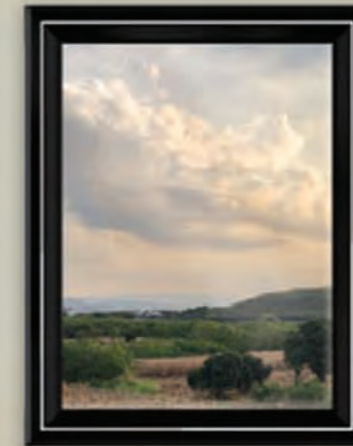

MODERN PICTURE FRAME

MODERN TF-2002

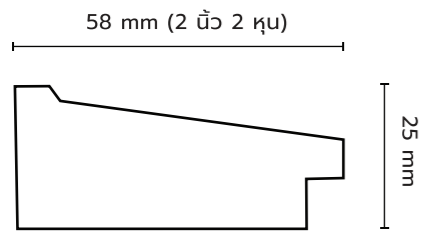

ขนาด : 58 มม. X 25 มม.
1 กล่อง : 22 เส้น (ยาว 3 ม.)

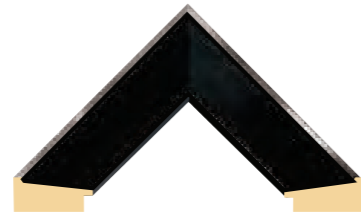

TF-2002-BM

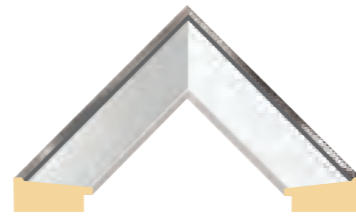

TF-2002-WM



TF-2002-T1

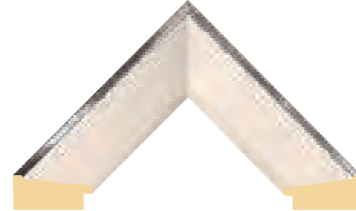

TF-2002-WC



TF-2002-WM1



TF-2002-GA

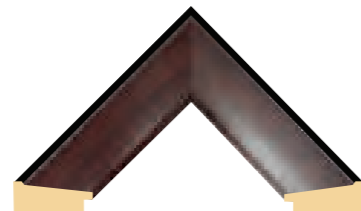

TF-2002-O3



TF-2002-WM2

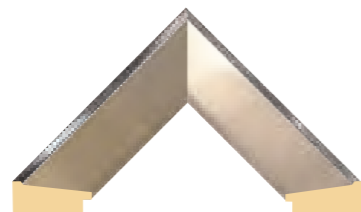

TF-2002-AT



TF-2002-GM

TF-2002-BM



MODERN PICTURE FRAME

MODERN —TF-3558

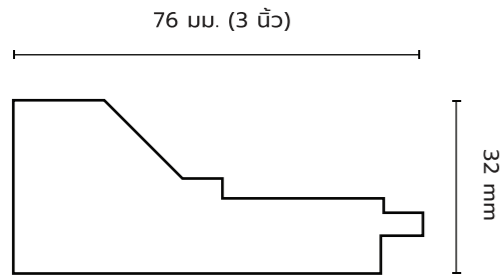

ขนาด : 76 มม. X 32 มม.
1 กล่อง : 12 เส้น (ยาว 3 ม.)

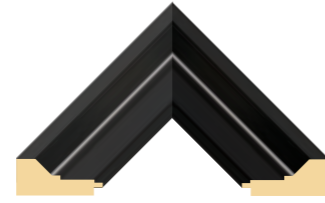

TF-3558-BM

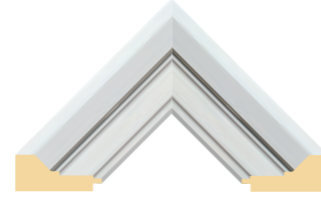

TF-3558-WM

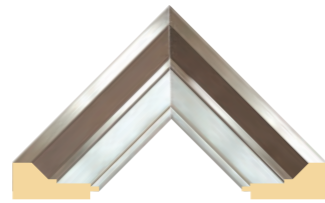

TF-3558-AS

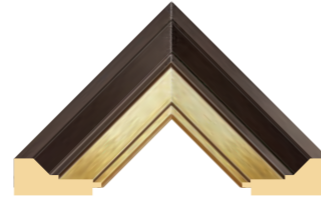

TF-3558-GA

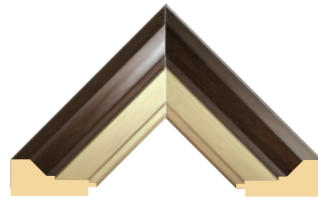

TF-3558-T1

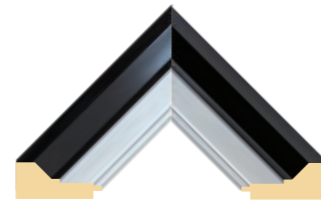

TF-3558-BW

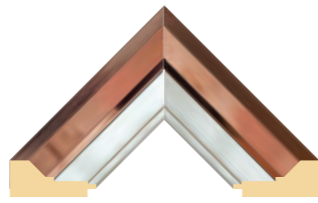

TF-3558-RS

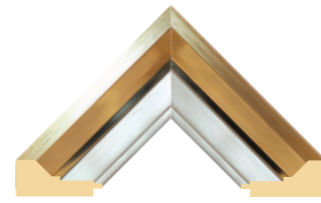

TF-3558-GM

TF-3558-BM

TF-3558-T1



MODERN PICTURE FRAME

MODERN —TF-4021

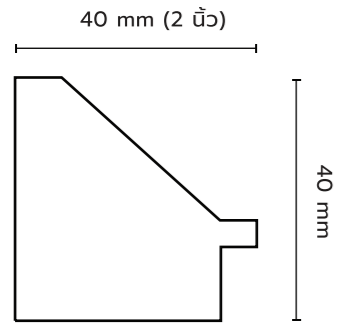

ขนาด : 40 มม. X 40 มม.
1 กล้อง : 20 เส้น (ยาว 3 ม.)

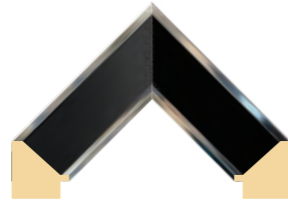

TF-4021-BM

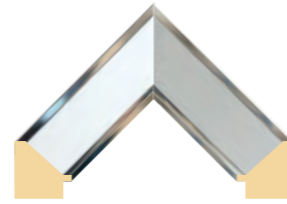

TF-4021-WM

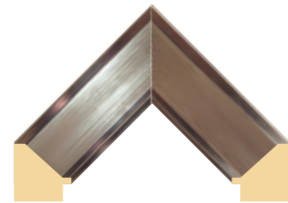

TF-4021-AT

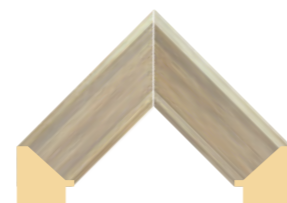

TF-4021-T1



TF-4021-O3

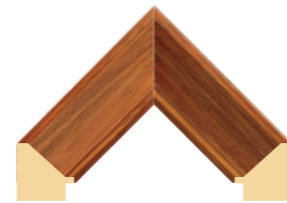

TF-4021-TR

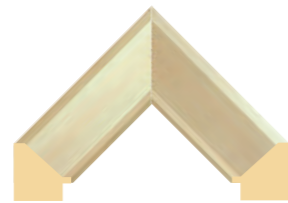

TF-4021-WC

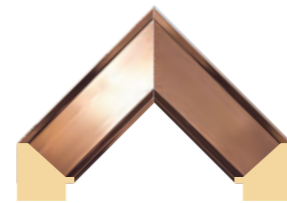

TF-4021-RM

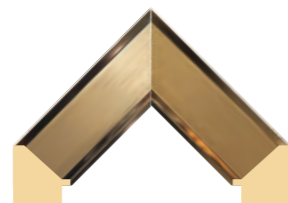

TF-4021-GM

TF-4021-O3



MODERN PICTURE FRAME

MODERN —TF-2215

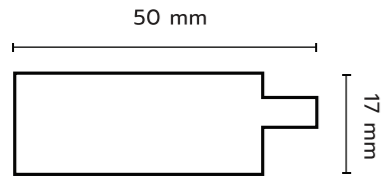

ຂາດ : 50 ມມ. X 17 ມມ.
1 ກ່ອງ : 35 ເສັ້ນ (ຍາກ 3 ມ.)



TF-2215-BM1



TF-2215-WM

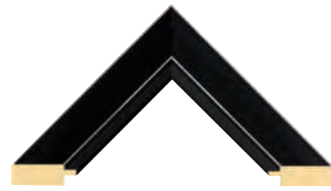

TF-2215-BM



TF-2215-O3

MINIMAL —TF-1157

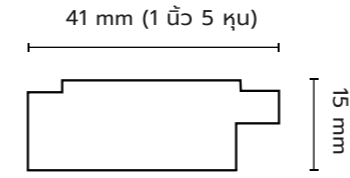

ຂາດ : 41 ມມ. X 15 ມມ.
1 ກ່ອງ : 40 ເສັ້ນ (ຍາກ 3 ມ.)



TF-1157-BM



TF-1157-SM

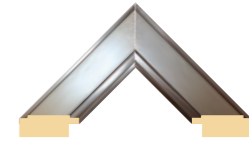

TF-1157-AT

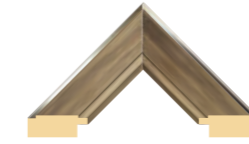

TF-1157-T2



TF-1157-O3



TF-1157-TR



TF-1157-T1

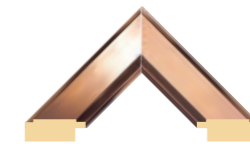

TF-1157-RM

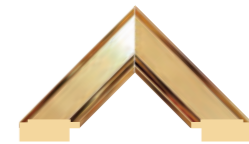

TF-1157-GM

TF-2215-O3



TF-1157-AT



TF-1157-BM



VINTAGE PICTURE FRAME

VINTAGE —TF-1029

29 mm (1 ជ័ក 1 អុម)

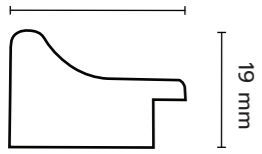

ឧបាទ : 29 មម. X 19 មម.
1 ក្លែង : 56 ត្រីន (មក 3 ម.)



TF-1029-O3



TF-1029-T21



TF-1029-BS



TF-1029-WC2



TF-1029-WC1



TF-1029-T22

VINTAGE —TF-3040

31 mm (1 ជ័ក 2 អុម)

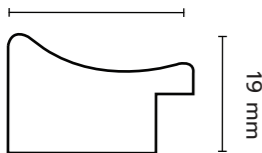

ឧបាទ : 31 មម. X 19 មម.
1 ក្លែង : 50 ត្រីន (មក 3 ម.)

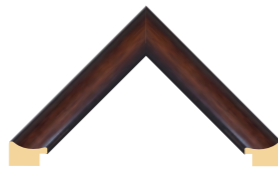

TF-3040-T2

VINTAGE —TF-3601

36 mm (1 ជ័ក 3 អុម)

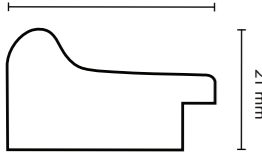

ឧបាទ : 36 មម. X 21 មម.
1 ក្លែង : 48 ត្រីន (មក 3 ម.)



TF-3601-OR



TF-3601-M3

TF-1029-BS



TF-1029-O3



TF-3601-OR



TF-3040-T2



VINTAGE PICTURE FRAME

VINTAGE —TF-2059

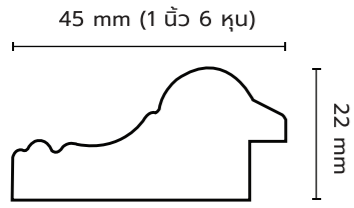

ឧបករណ៍ : 45 មម. X 22 មម.
1 ក្រណាត់ : 40 ទំព័រ (មធ្យម 3 ម.)



TF-2059-GM



TF-2059-O3



TF-2059-T1



TF-2059-MR

VINTAGE —TF-2552

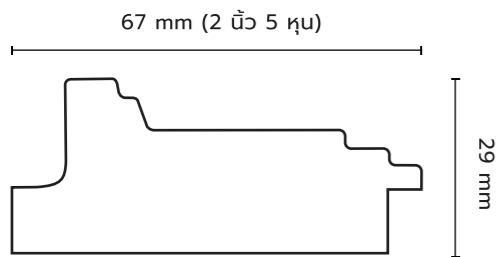

ឧបករណ៍ : 67 មម. X 29 មម.
1 ក្រណាត់ : 18 ទំព័រ (មធ្យម 3 ម.)



TF-2552-GM



TF-2552-O3



TF-2552-WC



TF-2552-BM



TF-2059-O3



TF-2552-O3



TF-2552-BM



VINTAGE PICTURE FRAME

VINTAGE —TF-2214

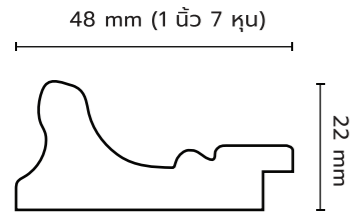

ຂາດ : 48 ມມ. X 22 ມມ.
1 ຄລ່ອງ : 32 ເສັ້ນ (ຍາກ 3 ມ.)



TF-2214-GM



TF-2214-T3



TF-2214-WC



TF-2214-O3

VINTAGE —TF-2555

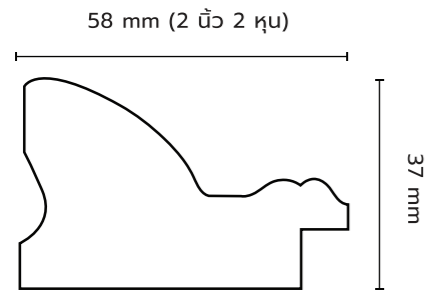

ຂາດ : 58 ມມ. X 37 ມມ.
1 ຄລ່ອງ : 16 ເສັ້ນ (ຍາກ 3 ມ.)



TF-2555-GS

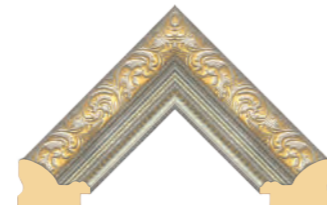

TF-2555-SM



TF-2555-GA



TF-2555-OR

TF-2555-GS

TF-2555-OR



TF-2214-GM



TF-2214-T3



VINTAGE PICTURE FRAME

VINTAGE —TF-3001

67 mm (2 ជ័រ 5 អុយ)

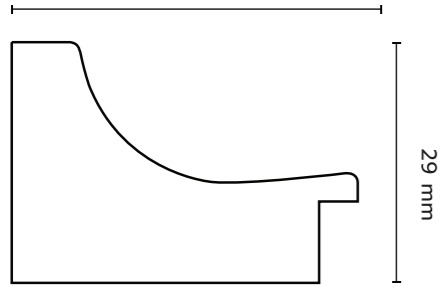

ឧបករណ៍ : 67 មម. X 29 មម.
1 ក្រណាត់ : 12 ទ្រីន (មែក 3 ម.)

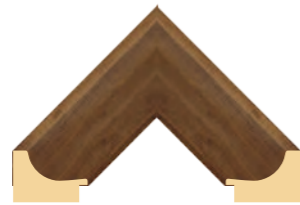

TF-3001-T2



TF-3001-GA2



TF-3001-GA1



TF-3001-O3



TF-3001-GD



TF-3001-WC

VINTAGE —TF-2008

60 mm (2 ជ័រ 3 អុយ)

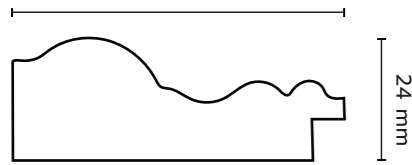

ឧបករណ៍ : 60 មម. X 24 មម.
1 ក្រណាត់ : 22 ទ្រីន (មែក 3 ម.)

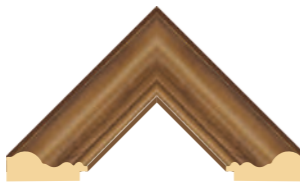

TF-2008-O1



TF-2008-SW



TF-2008-SC



TF-2008-SN



TF-2008-SB

TF-3001-GA1

TF-2008-O1



TF-2008-SN



SUNWU POLY
CO.,LTD.

บริษัท ชันวู โพลี จำกัด

42 หมู่ที่ 1 ตำบลคอกพระมือ
อำเภอเมืองสมุทรสาคร สมุทรสาคร 74000